

Part Number: WP7113BR5.08/SGD

Super Bright Green

Features

- LED FIRMLY HELD BY SPACER-NO ADDITIONAL FIXTURING OR GLUEING NECESSARY.
- SUITABLE FOR BACK PANEL ILLUMINATION,CIRCUIT BOARD INDICATOR, LED INDICATOR.
- UL RATING:94V-0.
- HOUSING MATERIAL:TYPE 66 NYLON.
- RoHS COMPLIANT.

Description

The Super Bright Green source color devices are made with Gallium Phosphide Green Light Emitting Diode.

Package Dimensions

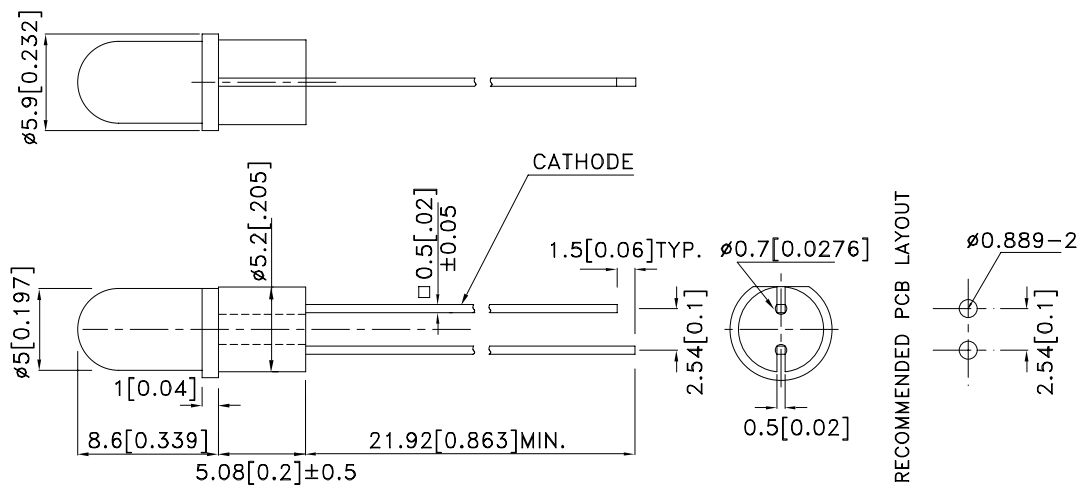

Notes:

1. All dimensions are in millimeters (inches).
2. Tolerance is $\pm 0.25 (0.01)$ unless otherwise noted.
3. Lead spacing is measured where the leads emerge from the package.
4. Specifications are subject to change without notice.



Selection Guide

Part No.	Dice	Lens Type	Iv (mcd) [2] @ 20mA		Viewing Angle [1]
			Min.	Typ.	2θ1/2
WP7113BR5.08/SGD	Super Bright Green (GaP)	GREEN DIFFUSED	18	40	30°

Notes:

1. θ1/2 is the angle from optical centerline where the luminous intensity is 1/2 the optical centerline value.
2. Luminous intensity/ luminous Flux: +/-15%.

Electrical / Optical Characteristics at TA=25°C

Symbol	Parameter	Device	Typ.	Max.	Units	Test Conditions
λ _{peak}	Peak Wavelength	Super Bright Green	565		nm	I _F =20mA
λ _D [1]	Dominant Wavelength	Super Bright Green	568		nm	I _F =20mA
Δλ _{1/2}	Spectral Line Half-width	Super Bright Green	30		nm	I _F =20mA
C	Capacitance	Super Bright Green	15		pF	V _F =0V;f=1MHz
V _F [2]	Forward Voltage	Super Bright Green	2.2	2.5	V	I _F =20mA
I _R	Reverse Current	Super Bright Green		10	uA	V _R = 5V

Notes:

1. Wavelength: +/-1nm.
2. Forward Voltage: +/-0.1V.

Absolute Maximum Ratings at TA=25°C

Parameter	Super Bright Green	Units
Power dissipation	62.5	mW
DC Forward Current	25	mA
Peak Forward Current [1]	140	mA
Reverse Voltage	5	V
Operating/Storage Temperature	-40°C To +85°C	
Lead Solder Temperature [2]	260°C For 3 Seconds	
Lead Solder Temperature [3]	260°C For 5 Seconds	

Notes:

1. 1/10 Duty Cycle, 0.1ms Pulse Width.
2. 2mm below package base.
3. 5mm below package base.



Super Bright Green WP7113BR5.08/SGD

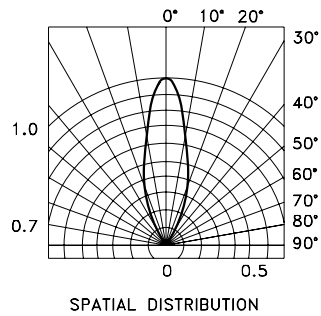
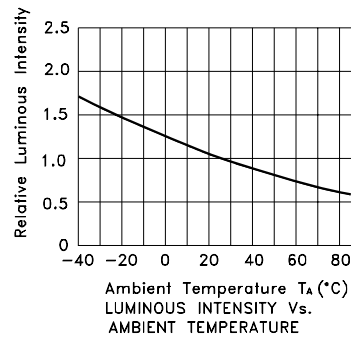
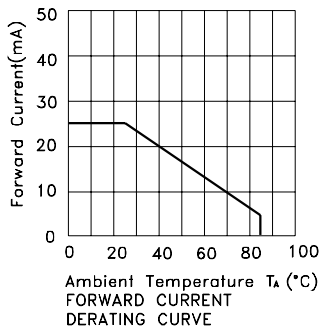
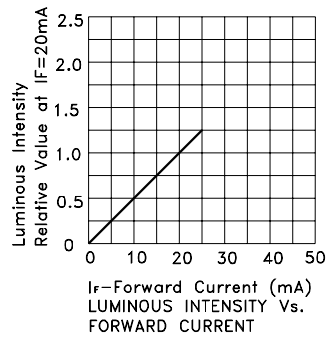

PACKING & LABEL SPECIFICATIONS

WP7113BR5.08/SGD

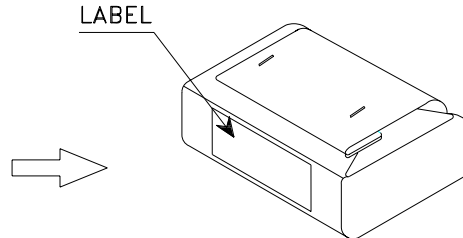
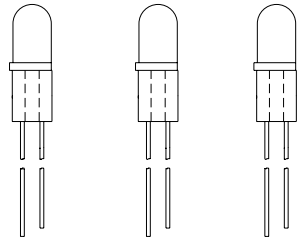

200PCS / BAG



12.8K / 9# BOX

OUTSIDE LABEL

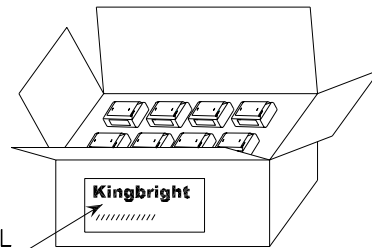

OUTSIDE LABEL

1.6K / 1# BOX

<h1>Kingbright</h1>				
Q.C.	<table border="1"> <tr> <td>QC</td> </tr> <tr> <td>XX XX XX</td> </tr> <tr> <td>PASSED</td> </tr> </table>	QC	XX XX XX	PASSED
QC				
XX XX XX				
PASSED				
TYPE NO : WP7113BRxxx				
QUANTITY : 200 pcs				
S/N : XX	CODE: XX			
LOT NO : 				
RoHS Compliant				