

APFA3011-AK13/F

3.0 x 1.0 mm Right Angle SMD Chip LED Lamp



DESCRIPTIONS

- The Blue source color devices are made with InGaN Light Emitting Diode
- The Hyper Red device is based on light emitting diode chip made from AlGaInP
- The Green source color devices are made with InGaN Light Emitting Diode
- Electrostatic discharge and power surge could damage the LEDs
- It is recommended to use a wrist band or anti-electrostatic glove when handling the LEDs
- All devices, equipments and machineries must be electrically grounded

FEATURES

- 3.0 x 1.5 x 1.0 mm right angle SMD LED, 1.0 mm thickness
- Low power consumption
- Wide viewing angle
- Ideal for backlight and indicator
- Package: 2000 pcs / reel
- Moisture sensitivity level: 3
- Halogen-free
- RoHS compliant

APPLICATIONS

- Backlight
- Status indicator
- Home and smart appliances
- Wearable and portable devices
- Healthcare applications

ATTENTION

Observe precautions for handling electrostatic discharge sensitive devices



PACKAGE DIMENSIONS

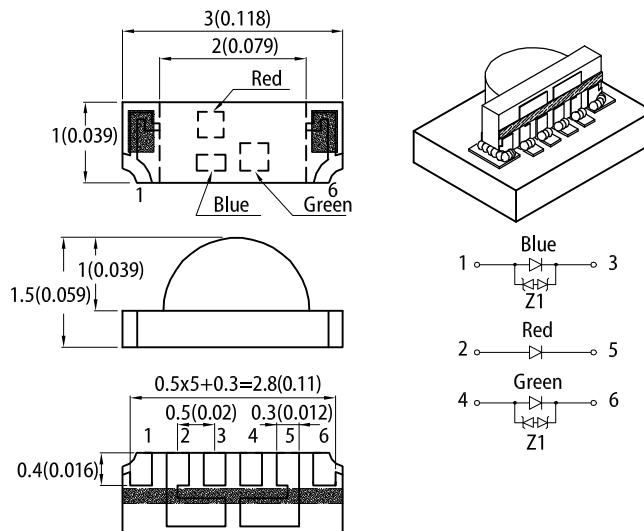

RECOMMENDED SOLDERING PATTERN

(units : mm; tolerance : ± 0.1)

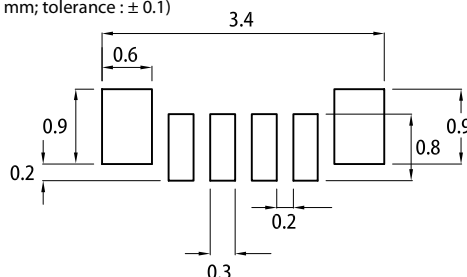

Notes:

1. All dimensions are in millimeters (inches).
2. Tolerance is $\pm 0.2(0.008)$ unless otherwise noted.
3. The specifications, characteristics and technical data described in the datasheet are subject to change without prior notice.
4. The device has a single mounting surface. The device must be mounted according to the specifications.

SELECTION GUIDE

Part Number	Emitting Color (Material)	Lens Type	Iv (mcd) @ 20mA ^[2]		Iv (mcd) ^[2] @B:R:G=15.6mA:19.1mA:20mA	Dice Chromaticity Coordinates		Viewing Angle ^[1]
			Min.	Typ.	Typ.	x (Typ.)	y (Typ.)	2θ1/2
APFA3011-AK13/F	Blue (InGaN)	Water Clear	80	150	1320	0.3	0.3	150°
	Hyper Red (AlGaInP)		200	410				
	Green (InGaN)		500	780				

Notes:

1. $\theta_{1/2}$ is the angle from optical centerline where the luminous intensity is 1/2 of the optical peak value.
2. Luminous intensity / luminous flux: +/-15%.
3. Luminous intensity value is traceable to CIE127-2007 standards.

ELECTRICAL / OPTICAL CHARACTERISTICS at T_A=25°C

Parameter	Symbol	Value			Unit
		Blue	Hyper Red	Green	
Wavelength at Peak Emission I _F = 20mA (typ)	λ _{peak}	465	640	520	nm
Dominant Wavelength I _F = 20mA (typ)	λ _{dom} ^[1]	470	625	525	nm
Spectral Bandwidth at 50% Φ REL MAX I _F = 20mA (typ)	Δλ	22	20	35	nm
Capacitance (typ)	C	100	27	100	pF
Forward Voltage I _F = 20mA (typ) (max)	V _F ^[2]	3.3 4.0	2.2 2.8	3.2 4.0	V
Reverse Current (V _R = 5V) (max)	I _R	50	10	50	μA
Temperature Coefficient of λ _{peak} I _F = 20mA, -10°C ≤ T ≤ 85°C (typ)	TC _{λpeak}	0.04	0.13	0.05	nm/°C
Temperature Coefficient of λ _{dom} I _F = 20mA, -10°C ≤ T ≤ 85°C (typ)	TC _{λdom}	0.03	0.06	0.03	nm/°C
Temperature Coefficient of V _F I _F = 20mA, -10°C ≤ T ≤ 85°C (typ)	TC _V	-3.0	-2.0	-3.0	mV/°C

Notes:

1. The dominant wavelength (λ_d) above is the setup value of the sorting machine. (Tolerance λ_d: ±1nm.)
2. Forward voltage: ±0.1V.
3. Wavelength value is traceable to CIE127-2007 standards.
4. Excess driving current and / or operating temperature higher than recommended conditions may result in severe light degradation or premature failure.

ABSOLUTE MAXIMUM RATINGS at T_A=25°C

Parameter	Symbol	Value			Unit
		Blue	Hyper Red	Green	
Power Dissipation	P _D	120	84	120	mW
Reverse Voltage	V _R	5	5	5	V
Junction Temperature	T _j	115	115	115	°C
Operating Temperature	T _{op}	-40 to +85			°C
Storage Temperature	T _{stg}	-40 to +85			°C
DC Forward Current	I _F	30	30	30	mA
Peak Forward Current	I _{FM} ^[1]	100	150	100	mA
Electrostatic Discharge Threshold (HBM)	-	8000	3000	8000	V
Thermal Resistance (Junction / Ambient)	R _{th JA} ^[2]	500	520	680	°C/W
Thermal Resistance (Junction / Solder point)	R _{th JS} ^[2]	390	440	570	°C/W

Notes:

1. 1/10 Duty Cycle, 0.1ms Pulse Width.
2. R_{th JA}, R_{th JS} Results from mounting on PC board FR4 (pad size ≥ 16 mm² per pad).
3. Relative humidity levels maintained between 40% and 60% in production area are recommended to avoid the build-up of static electricity – Ref JEDEC/JESD625-A and JEDEC/J-STD-033.

TECHNICAL DATA

RELATIVE INTENSITY vs. WAVELENGTH

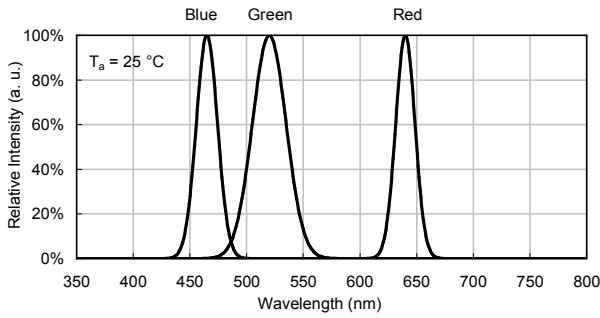

SPATIAL DISTRIBUTION

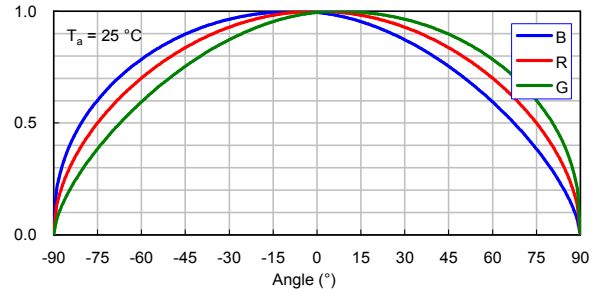

BLUE

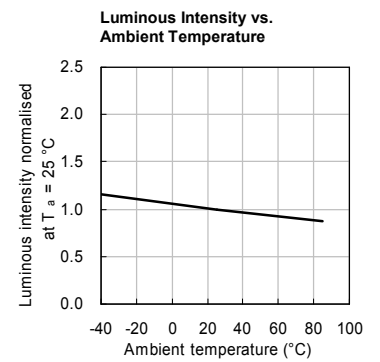
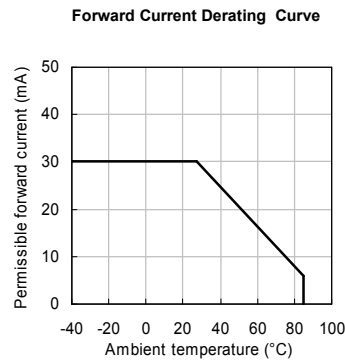
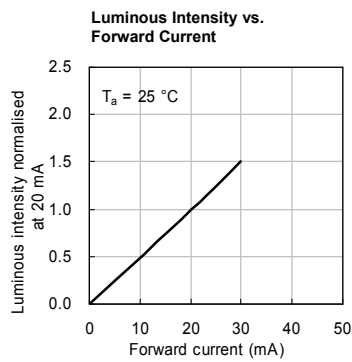
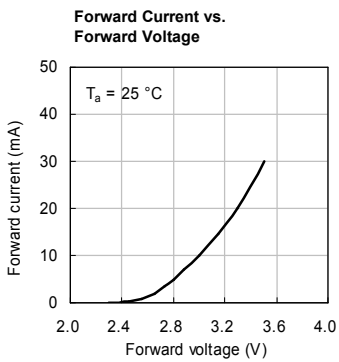

HYPER RED

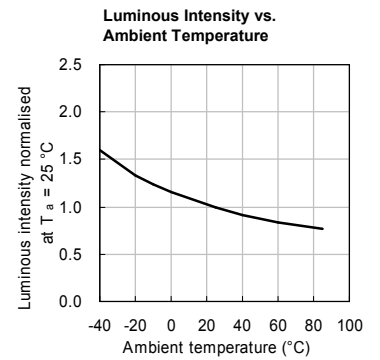
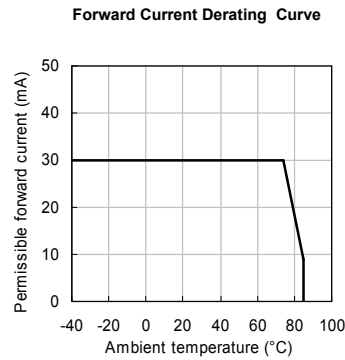
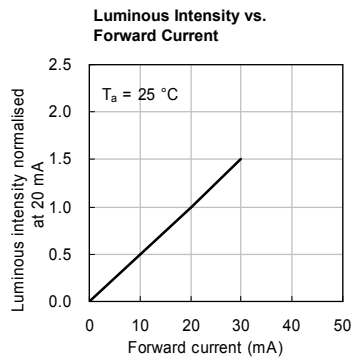
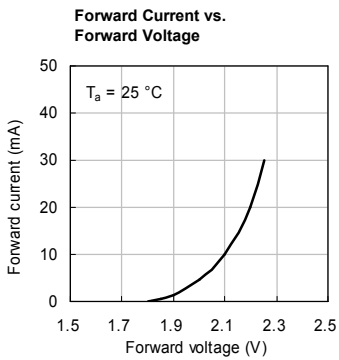

GREEN

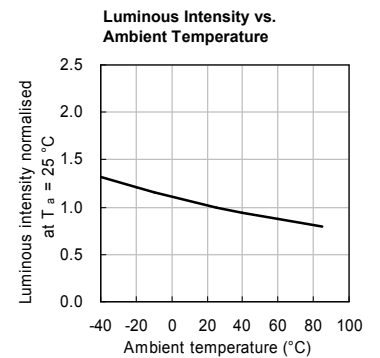
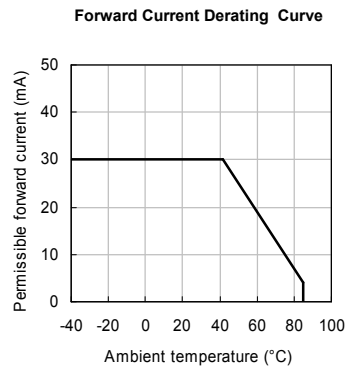
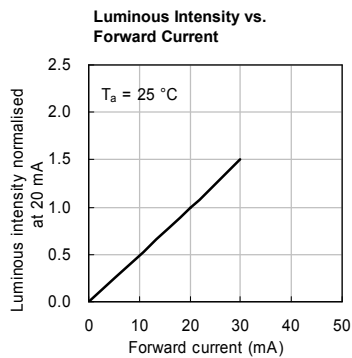
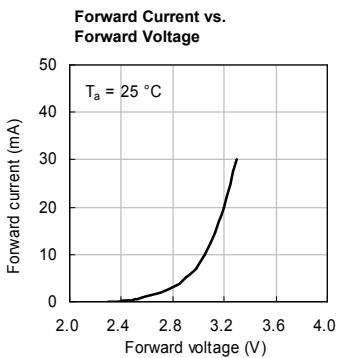

CIE CHROMATICITY DIAGRAM

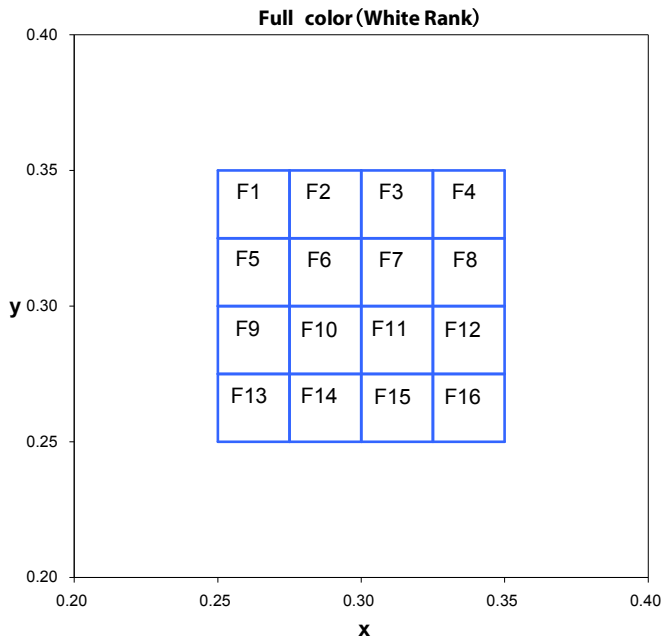

Notes:
 Shipment may contain more than one chromaticity regions.
 Orders for single chromaticity region are generally not accepted.
 Measurement tolerance of the chromaticity coordinates is ± 0.01 .

	x	y		x	y		x	y		x	y
F1	0.250	0.325	F5	0.250	0.300	F9	0.250	0.275	F13	0.250	0.250
	0.275	0.325		0.275	0.300		0.275	0.275		0.275	0.250
	0.275	0.350		0.275	0.325		0.275	0.300		0.275	0.275
	0.250	0.350		0.250	0.325		0.250	0.300		0.250	0.275
F2	0.275	0.325	F6	0.275	0.300	F10	0.275	0.275	F14	0.275	0.250
	0.300	0.325		0.300	0.300		0.300	0.275		0.300	0.250
	0.300	0.350		0.300	0.325		0.300	0.300		0.300	0.275
	0.275	0.350		0.275	0.325		0.275	0.300		0.275	0.275
F3	0.300	0.325	F7	0.300	0.300	F11	0.300	0.275	F15	0.300	0.250
	0.325	0.325		0.325	0.300		0.325	0.275		0.325	0.250
	0.325	0.350		0.325	0.325		0.325	0.300		0.325	0.275
	0.300	0.350		0.300	0.325		0.300	0.300		0.300	0.275
F4	0.325	0.325	F8	0.325	0.300	F12	0.325	0.275	F16	0.325	0.250
	0.350	0.325		0.350	0.300		0.350	0.275		0.350	0.250
	0.350	0.350		0.350	0.325		0.350	0.300		0.350	0.275
	0.325	0.350		0.325	0.325		0.325	0.300		0.325	0.275

REFLOW SOLDERING PROFILE for LEAD-FREE SMD PROCESS

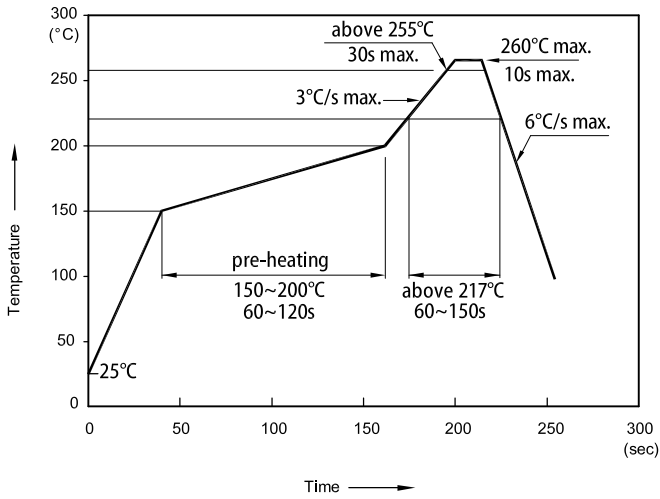

- Notes:
1. Don't cause stress to the LEDs while it is exposed to high temperature.
 2. The maximum number of reflow soldering passes is 2 times.
 3. Reflow soldering is recommended. Other soldering methods are not recommended as they might cause damage to the product.

TAPE SPECIFICATIONS (units : mm)

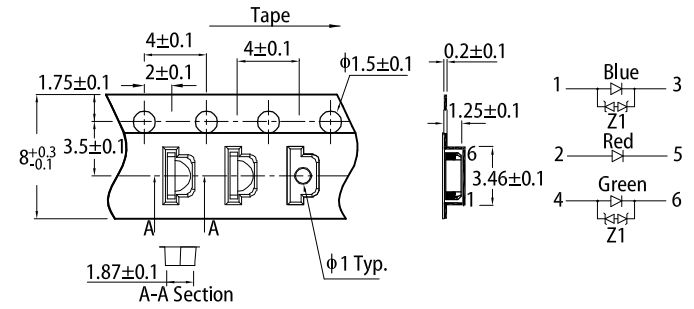

REEL DIMENSION (units : mm)

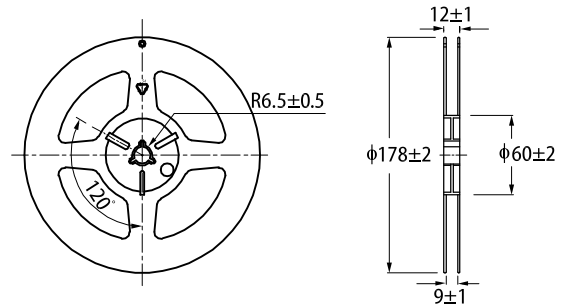

PACKING & LABEL SPECIFICATIONS

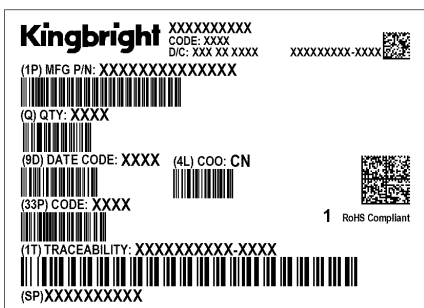
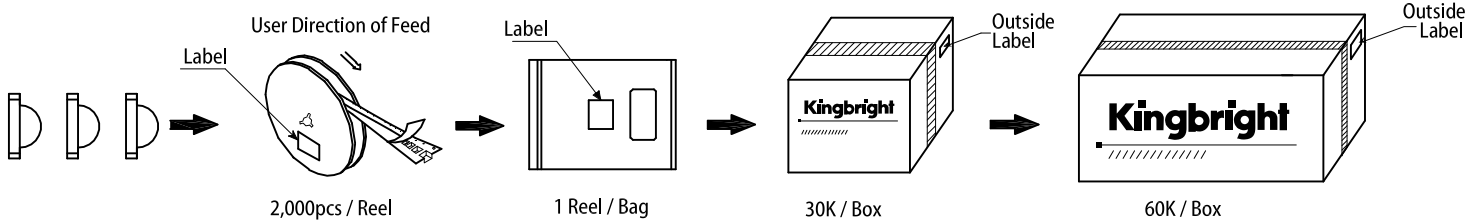

PRECAUTIONARY NOTES

1. The information included in this document reflects representative usage scenarios and is intended for technical reference only.
2. The part number, type, and specifications mentioned in this document are subject to future change and improvement without notice. Before production usage customer should refer to the latest datasheet for the updated specifications.
3. When using the products referenced in this document, please make sure the product is being operated within the environmental and electrical limits specified in the datasheet. If customer usage exceeds the specified limits, Kingbright will not be responsible for any subsequent issues.
4. The information in this document applies to typical usage in consumer electronics applications. If customer's application has special reliability requirements or have life-threatening liabilities, such as automotive or medical usage, please consult with Kingbright representative for further assistance.
5. The contents and information of this document may not be reproduced or re-transmitted without permission by Kingbright.
6. All design applications should refer to Kingbright application notes available at <https://www.KingbrightUSA.com/ApplicationNotes>