

## AA4040LQWS/D-AMT

4.0 x 4.0 mm Right Angle Surface Mount LED Lamp

### DESCRIPTIONS

- The source color devices are made with InGaN Light Emitting Diode
- Electrostatic discharge and power surge could damage the LEDs
- It is recommended to use a wrist band or anti-electrostatic glove when handling the LEDs
- All devices, equipments and machineries must be electrically grounded

### FEATURES

- Single color
- Suitable for all SMD assembly and solder process
- Available on tape and reel
- Ideal for backlighting
- Package: 500 pcs / reel
- Moisture sensitivity level: 3
- Halogen-free
- RoHS compliant

### APPLICATIONS

- Traffic signaling
- Backlighting (illuminated advertising , general lighting)
- Interior and exterior automotive lighting
- Substitution of micro incandescent lamps
- Reading lamps
- Signal and symbol luminaire for orientation
- Marker lights (e.g. Steps, exit ways, etc)
- Decorative and entertainment lighting
- Indoor and outdoor commercial and residential architectural lighting

### ATTENTION

Observe precautions for handling electrostatic discharge sensitive devices



### SELECTION GUIDE

Part Number	Emitting Color (Material)	Lens Type	Iv (mcd) @ 2mA <sup>[2]</sup>			Viewing Angle <sup>[1]</sup>
			Code.	Min.	Max.	2θ1/2
AA4040LQWS/D-AMT	White (InGaN)	Yellow Fluorescent	U	50	80	120°
			V	80	120	
			W	120	180	

- Notes:
1. θ1/2 is the angle from optical centerline where the luminous intensity is 1/2 of the optical peak value.
  2. Luminous intensity / luminous flux: +/-15%.
  3. Luminous intensity value is traceable to CIE127-2007 standards.
  4. LEDs will be provided from the listed bin codes. The bins delivered to the customer will be at Kingbright's discretion.

### PACKAGE DIMENSIONS

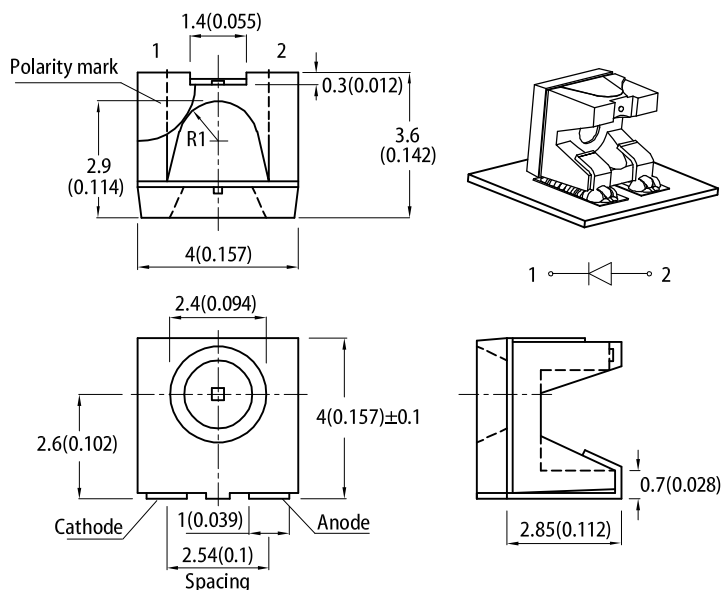

### RECOMMENDED SOLDERING PATTERN

(units : mm; tolerance : ± 0.1)

Pad design for improved heat dissipation

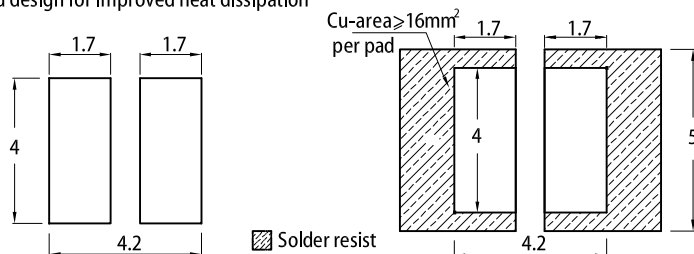

- Notes:
1. All dimensions are in millimeters (inches).
  2. Tolerance is ±0.25(0.01") unless otherwise noted.
  3. The specifications, characteristics and technical data described in the datasheet are subject to change without prior notice.
  4. The device has a single mounting surface. The device must be mounted according to the specifications.

ELECTRICAL / OPTICAL CHARACTERISTICS at  $T_A=25^\circ\text{C}$ 

Parameter	Symbol	Emitting Color	Value		Unit
			Typ.	Max.	
Chromaticity Coordinates x $I_F = 2\text{mA}$	$x^{[1]}$	White	0.31		-
Chromaticity Coordinates y $I_F = 2\text{mA}$	$y^{[1]}$	White	0.31	-	-
Capacitance	C	White	100	-	pF
Forward Voltage $I_F = 2\text{mA}$	$V_F^{[2]}$	White	2.65	3.1	V
Reverse Current ( $V_R = 5\text{V}$ )	$I_R$	White	-	50	$\mu\text{A}$
Temperature Coefficient of x $I_F = 2\text{mA}$ , $-10^\circ\text{C} \leq T \leq 100^\circ\text{C}$	$TC_x$	White	-0.17	-	$10^{-3}/^\circ\text{C}$
Temperature Coefficient of y $I_F = 2\text{mA}$ , $-10^\circ\text{C} \leq T \leq 100^\circ\text{C}$	$TC_y$	White	-0.18	-	$10^{-3}/^\circ\text{C}$
Temperature Coefficient of $V_F$ $I_F = 2\text{mA}$ , $-10^\circ\text{C} \leq T \leq 100^\circ\text{C}$	$TC_V$	White	-3.0	-	$\text{mV}/^\circ\text{C}$

## Notes:

1. Measurement tolerance of the chromaticity coordinates is  $\pm 0.01$ .
2. Forward voltage:  $\pm 0.1\text{V}$ .
3. Excess driving current and / or operating temperature higher than recommended conditions may result in severe light degradation or premature failure.

ABSOLUTE MAXIMUM RATINGS at  $T_A=25^\circ\text{C}$ 

Parameter	Symbol	Value	Unit
Power Dissipation	$P_D$	80	mW
Reverse Voltage	$V_R$	5	V
Junction Temperature	$T_j$	115	$^\circ\text{C}$
Operating Temperature	$T_{op}$	-40 to +100	$^\circ\text{C}$
Storage Temperature	$T_{stg}$	-40 to +110	$^\circ\text{C}$
DC Forward Current	$I_F$	20	mA
Peak Forward Current	$I_{FM}^{[1]}$	100	mA
Electrostatic Discharge Threshold (HBM)	-	250	V
Thermal Resistance (Junction / Ambient)	$R_{th JA}^{[2]}$	450	$^\circ\text{C}/\text{W}$
Thermal Resistance (Junction / Solder point)	$R_{th JS}^{[2]}$	320	$^\circ\text{C}/\text{W}$

## Notes:

1. 1/10 Duty Cycle, 0.1ms Pulse Width.
2.  $R_{th JA}$ ,  $R_{th JS}$  Results from mounting on PC board FR4 (pad size  $\geq 16\text{ mm}^2$  per pad).
3. Relative humidity levels maintained between 40% and 60% in production area are recommended to avoid the build-up of static electricity – Ref JEDEC/JESD625-A and JEDEC/J-STD-033.

### TECHNICAL DATA

#### SPATIAL DISTRIBUTION

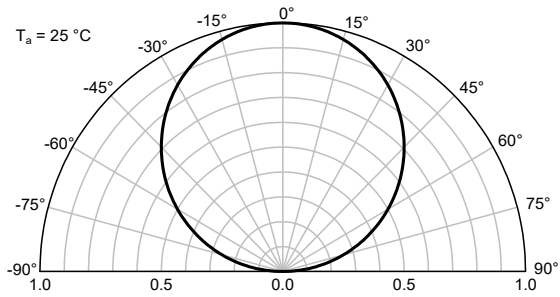

### WHITE

Forward Current vs. Forward Voltage

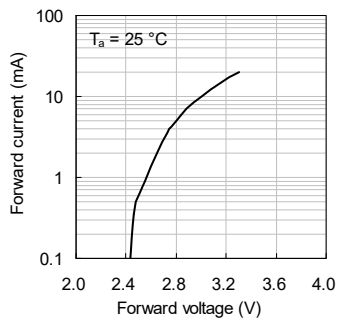

Luminous Intensity vs. Forward Current

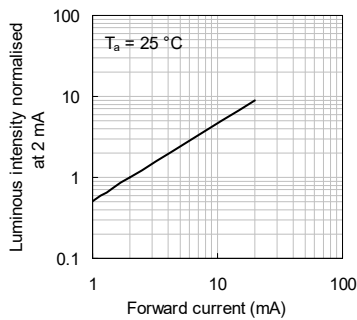

Forward Current Derating Curve

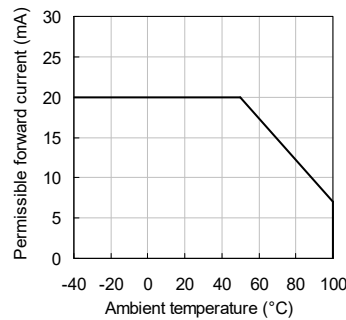

Luminous Intensity vs. Ambient Temperature

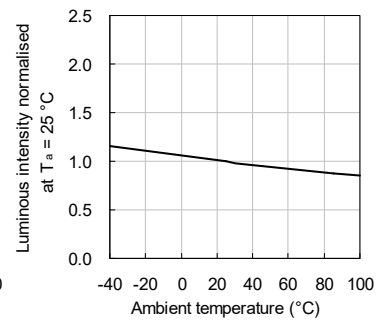

#### CIE CHROMATICITY DIAGRAM

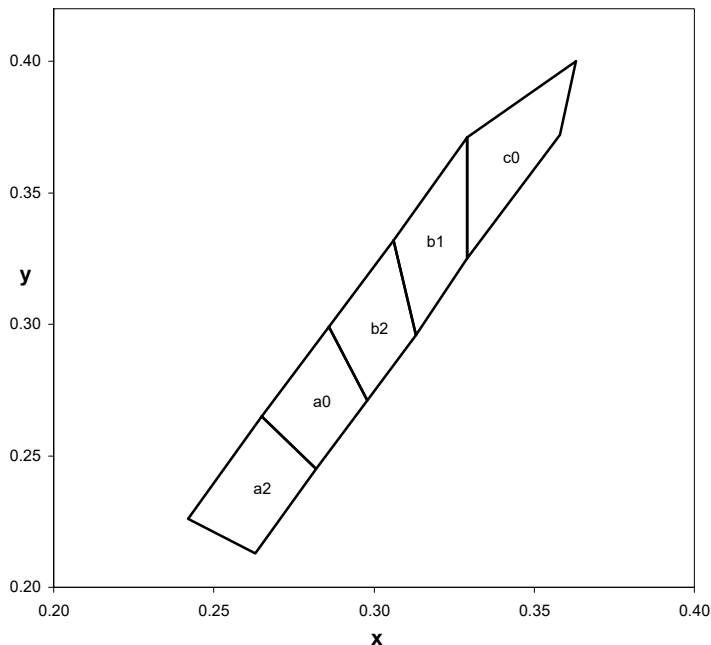

		x	y			
a2		0.263	0.213	a0	0.282	0.245
		0.282	0.245		0.298	0.271
		0.265	0.265		0.286	0.299
		0.242	0.226		0.265	0.265
b2		0.298	0.271	b1	0.313	0.296
		0.313	0.296		0.329	0.325
		0.306	0.332		0.329	0.371
		0.286	0.299		0.306	0.332
c0		0.329	0.325			
		0.358	0.372			
		0.363	0.400			
		0.329	0.371			

Notes:  
 Shipment may contain more than one chromaticity regions.  
 Orders for single chromaticity region are generally not accepted.  
 Measurement tolerance of the chromaticity coordinates is  $\pm 0.01$ .

### REFLOW SOLDERING PROFILE for LEAD-FREE SMD PROCESS

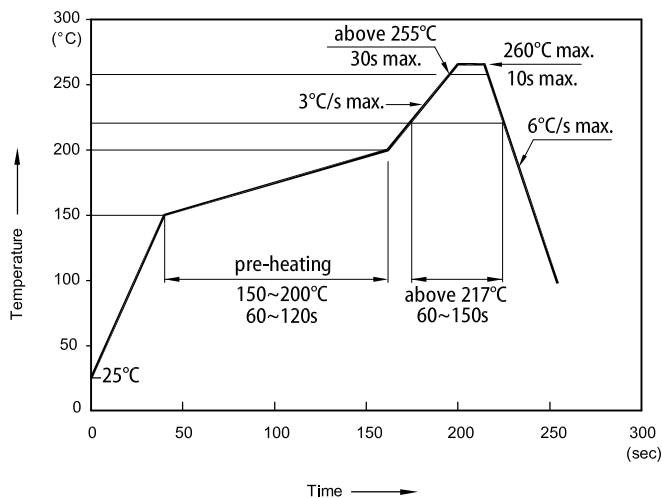

- Notes:
1. Don't cause stress to the LEDs while it is exposed to high temperature.
  2. The maximum number of reflow soldering passes is 2 times.
  3. Reflow soldering is recommended. Other soldering methods are not recommended as they might cause damage to the product.

### TAPE SPECIFICATIONS (units : mm)

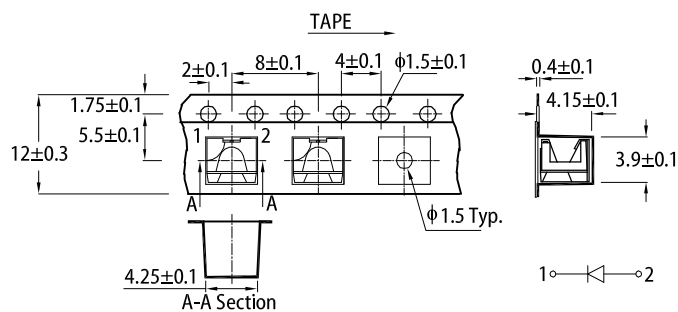

### REEL DIMENSION (units : mm)

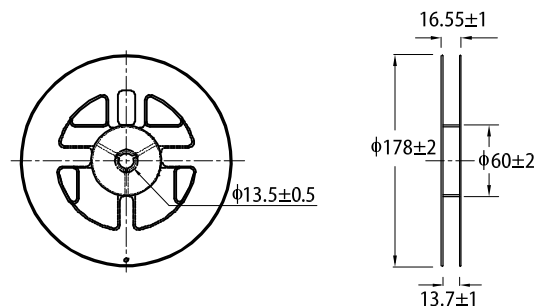

### HANDLING PRECAUTIONS

Compare to epoxy encapsulant that is hard and brittle, silicone is softer and flexible. Although its characteristic significantly reduces thermal stress, it is more susceptible to damage by external mechanical force. As a result, special handling precautions need to be observed during assembly using silicone encapsulated LED products. Failure to comply might lead to damage and premature failure of the LED.

1. Handle the component along the side surfaces by using forceps or appropriate tools.

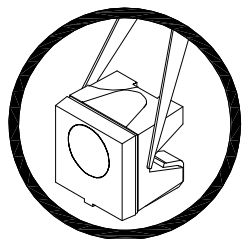

2. Do not directly touch or handle the silicone lens surface. It may damage the internal circuitry.

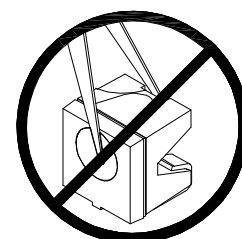
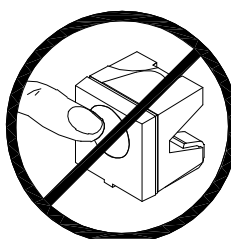

3. As silicone encapsulation is permeable to gases, some corrosive substances such as H<sub>2</sub>S might corrode silver plating of lead frame. Special care should be taken if an LED with silicone encapsulation is to be used near such substances.

**RELIABILITY TEST ITEMS AND CONDITIONS**

The reliability of products shall be satisfied with items listed below

**LOT TOLERANCE PERCENT DEFECTIVE (LTPD): 10%**

No.	Test Item	Standards	Test Condition	Test Times / Cycles	Number of Damaged
1	Continuous operating test	-	$T_a = 25^{\circ}\text{C}$ , $I_F = \text{maximum rated current}^*$	1,000 h	0 / 22
2	High Temp. operating test	EIAJ ED-4701/100(101)	$T_a = 100^{\circ}\text{C}$ , $I_F = \text{maximum rated current}^*$	1,000 h	0 / 22
3	Low Temp. operating test	-	$T_a = -40^{\circ}\text{C}$ , $I_F = \text{maximum rated current}^*$	1,000 h	0 / 22
4	High temp. storage test	EIAJ ED-4701/100(201)	$T_a = \text{maximum rated storage temperature}$	1,000 h	0 / 22
5	Low temp. storage test	EIAJ ED-4701/100(202)	$T_a = -40^{\circ}\text{C}$	1,000 h	0 / 22
6	High temp. & humidity storage test	-	$T_a = 60^{\circ}\text{C}$ , RH = 90%	500 h	0 / 22
7	High temp. & humidity operating test	-	$T_a = 60^{\circ}\text{C}$ , RH = 90% $I_F = \text{maximum rated current}^*$	500 h	0 / 22
8	Soldering reliability test	EIAJ ED-4701/100(301)	Moisture soak: $30^{\circ}\text{C}$ , 70% RH, 72h Preheat: $150\sim 180^{\circ}\text{C}$ (120s max.) Soldering temp: $260^{\circ}\text{C}$ (10s)	2 times	0 / 18
9	Thermal shock operating test	-	$T_a = -40^{\circ}\text{C}$ (15min) ~ $100^{\circ}\text{C}$ (15min) $I_F = \text{derated current at } 100^{\circ}\text{C}$	1,000 cycles	0 / 22
10	Thermal shock test	-	$T_a = -40^{\circ}\text{C}$ (15min) ~ maximum rated storage temperature(15min)	1,000 cycles	0 / 22
11	Electric Static Discharge (ESD)	EIAJ ED-4701/100(304)	$C = 100\text{pF}$ , $R_2 = 1.5\text{K}\Omega$ $V = 250\text{V}$	Once each Polarity	0 / 22
12	Vibration test	-	$a = 196\text{m/s}^2$ , $f = 100\sim 2\text{KHz}$ , $t = 48\text{min}$ for all xyz axes	4 times	0 / 22

\* : Refer to forward current vs. derating curve diagram

**CRITERIA FOR JUDGING DAMAGE**

Items	Symbols	Conditions	Failure Criteria
luminous Intensity	$I_V$	$I_F = 2\text{mA}$	Testing Min. Value < Spec. Min. Value x 0.5
Forward Voltage	$V_F$	$I_F = 2\text{mA}$	Testing Max. Value $\geq$ Spec. Max. Value x 1.2
Reverse Current	$I_R$	$V_R = \text{Maximum Rated Reverse Voltage}$	Testing Max. Value $\geq$ Spec. Max. Value x 2.5
High temp. storage test	-	-	Occurrence of notable decoloration, deformation and cracking

### PACKING & LABEL SPECIFICATIONS

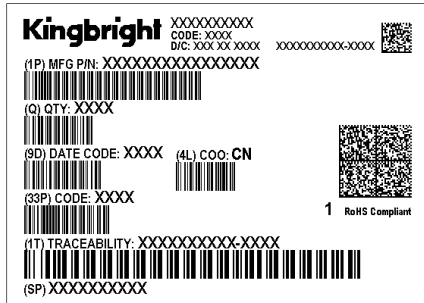
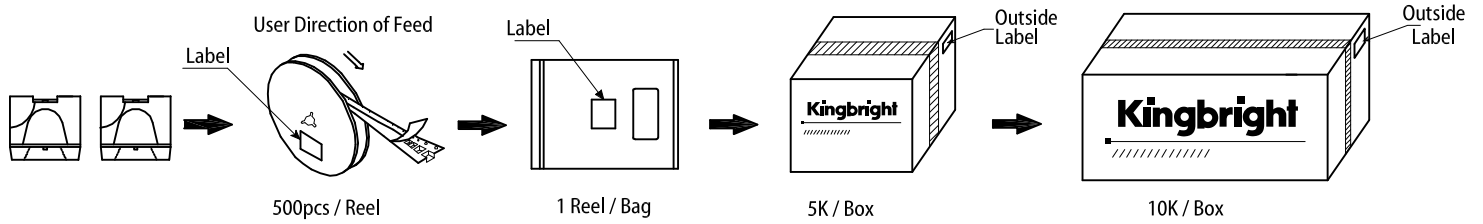

### PRECAUTIONARY NOTES

1. The information included in this document reflects representative usage scenarios and is intended for technical reference only.
2. The part number, type, and specifications mentioned in this document are subject to future change and improvement without notice. Before production usage customer should refer to the latest datasheet for the updated specifications.
3. When using the products referenced in this document, please make sure the product is being operated within the environmental and electrical limits specified in the datasheet. If customer usage exceeds the specified limits, Kingbright will not be responsible for any subsequent issues.
4. The information in this document applies to typical usage in consumer electronics applications. If customer's application has special reliability requirements or have life-threatening liabilities, such as automotive or medical usage, please consult with Kingbright representative for further assistance.
5. The contents and information of this document may not be reproduced or re-transmitted without permission by Kingbright.
6. All design applications should refer to Kingbright application notes available at <https://www.KingbrightUSA.com/ApplicationNotes>