



**ATTENTION**  
OBSERVE PRECAUTIONS  
FOR HANDLING  
ELECTROSTATIC  
DISCHARGE  
SENSITIVE  
DEVICES

Part Number: APTB1612CGKQWDF

Green  
White

### Features

- 1.6mmx1.25mm SMD LED, 0.65mm thickness.
- Bi-color, low power consumption.
- Wide viewing angle.
- Ideal for backlight and indicator.
- Package : 2000pcs / reel.
- Moisture sensitivity level : level 3.
- RoHS compliant.

### Descriptions

- The Green source color devices are made with AlGaInP on GaAs substrate Light Emitting Diode.
- The source color devices are made with InGaN Light Emitting Diode.
- Electrostatic discharge and power surge could damage the LEDs.
- It is recommended to use a wrist band or anti-electrostatic glove when handling the LEDs.
- All devices, equipments and machineries must be electrically grounded.

### Package Dimensions

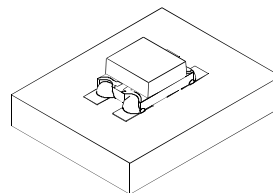
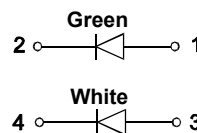
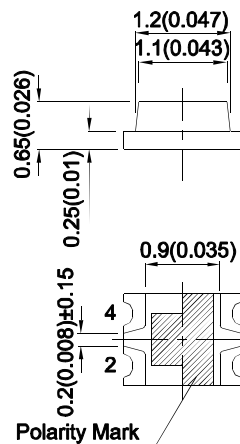
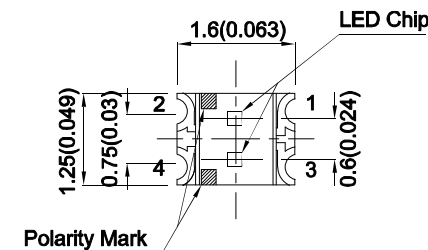

Notes:

1. All dimensions are in millimeters (inches).
2. Tolerance is  $\pm 0.2(0.008)$  unless otherwise noted.
3. The specifications, characteristics and technical data described in the datasheet are subject to change without prior notice.
4. The device has a single mounting surface. The device must be mounted according to the specifications.



## Selection Guide

Part No.	Emitting Color (Material)	Lens Type	Iv (mcd) [2] @ 20mA		Viewing Angle [1]
			Min.	Typ.	2θ1/2
APTB1612CGKQWDF	Green (AlGaInP)	Yellow Fluorescent	20	50	160°
	White (InGaN)		120	250	

Notes:

1. θ1/2 is the angle from optical centerline where the luminous intensity is 1/2 of the optical peak value.
2. Luminous intensity / luminous Flux: +/-15%.
3. Luminous intensity value is traceable to CIE127-2007 standards.

## Electrical / Optical Characteristics at TA=25°C [Green]

Symbol	Parameter	Emitting Color	Typ.	Max.	Units	Test Conditions
λ <sub>peak</sub>	Peak Wavelength	Green	574		nm	I <sub>F</sub> =20mA
λ <sub>D</sub> [1]	Dominant Wavelength	Green	570		nm	I <sub>F</sub> =20mA
Δλ <sub>1/2</sub>	Spectral Line Half-width	Green	20		nm	I <sub>F</sub> =20mA
C	Capacitance	Green	15		pF	V <sub>F</sub> =0V;f=1MHz
V <sub>F</sub> [2]	Forward Voltage	Green	2.1	2.5	V	I <sub>F</sub> =20mA
I <sub>R</sub>	Reverse Current	Green		10	uA	V <sub>R</sub> = 5V

Notes:

1. Wavelength: +/-1nm.
2. Forward Voltage: +/-0.1V.
3. Wavelength value is traceable to CIE127-2007 standards.
4. Excess driving current and / or operating temperature higher than recommended conditions may result in severe light degradation or premature failure.

## Electrical / Optical Characteristics at TA=25°C [White]

Symbol	Parameter	Emitting Color	Typ.	Max.	Units	Test Conditions
V <sub>F</sub> [1]	Forward Voltage	White	3.3	4.0	V	I <sub>F</sub> =20mA
I <sub>R</sub>	Reverse Current	White		50	uA	V <sub>R</sub> = 5V
x [2]	Chromaticity Coordinates	White	0.31			
y [2]			0.31			
C	Capacitance	White	100		pF	V <sub>F</sub> =0V;f=1MHz

Notes:

1. Forward Voltage: +/-0.1V.
2. Measurement Tolerance Of The Chromaticity Coordinates Is ±0.01.
3. Excess driving current and/or operating temperature higher than recommended conditions may result in severe light degradation or premature failure.

## Absolute Maximum Ratings at TA=25°C

Parameter	Green	White	Units
Power dissipation	75	120	mW
DC Forward Current	30	30	mA
Peak Forward Current [1]	150	150	mA
Electrostatic Discharge Threshold (HBM)	3000	250	V
Reverse Voltage	5		V
Operating Temperature	-40°C To +85°C		
Storage Temperature	-40°C To +85°C		

**Notes:**

- 1/10 Duty Cycle, 0.1ms Pulse Width.
- Relative humidity levels maintained between 40% and 60% in production area are recommended to avoid the build-up of static electricity – Ref JEDEC/JESD625-A and JEDEC/J-STD-033.

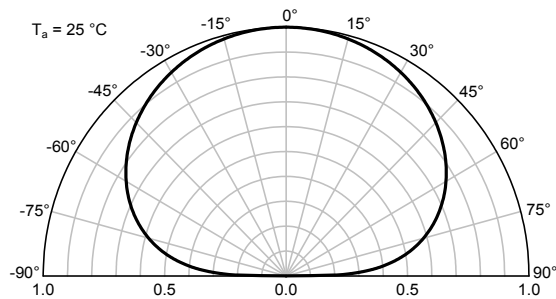
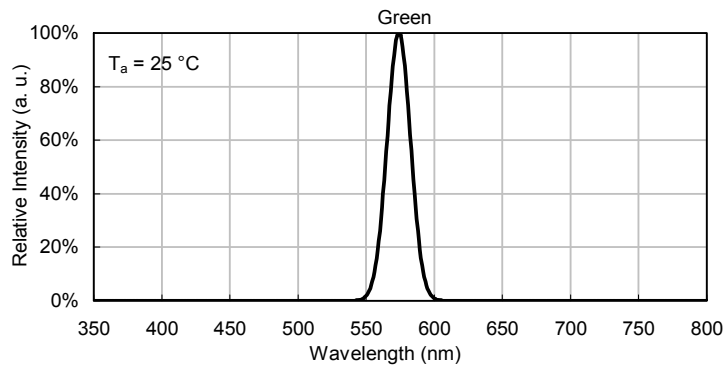

## APTB1612CGKQWDF Green

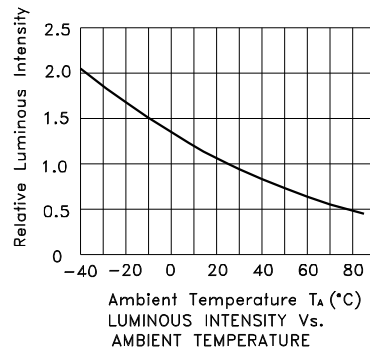
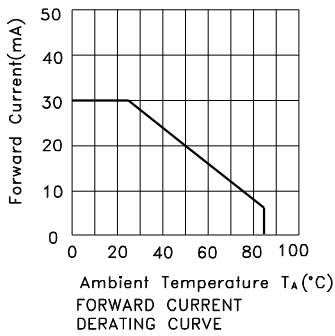
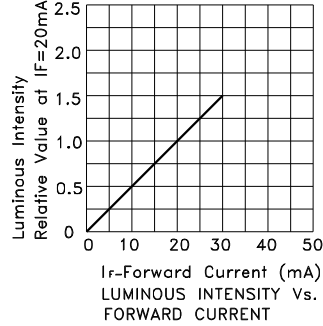
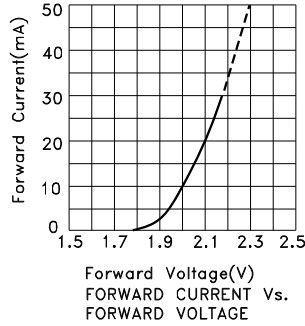

## White

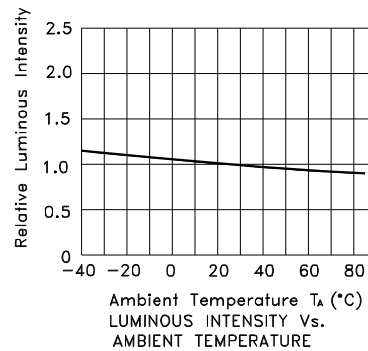
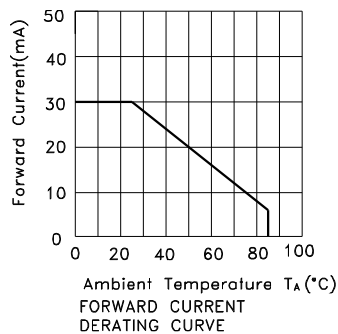
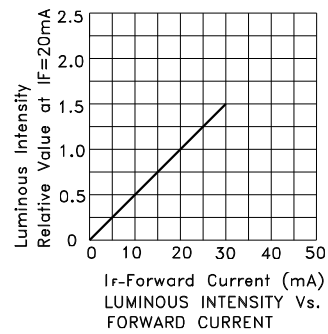
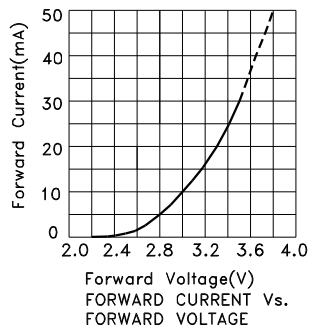

APTB1612CGKQWDF

## White CIE

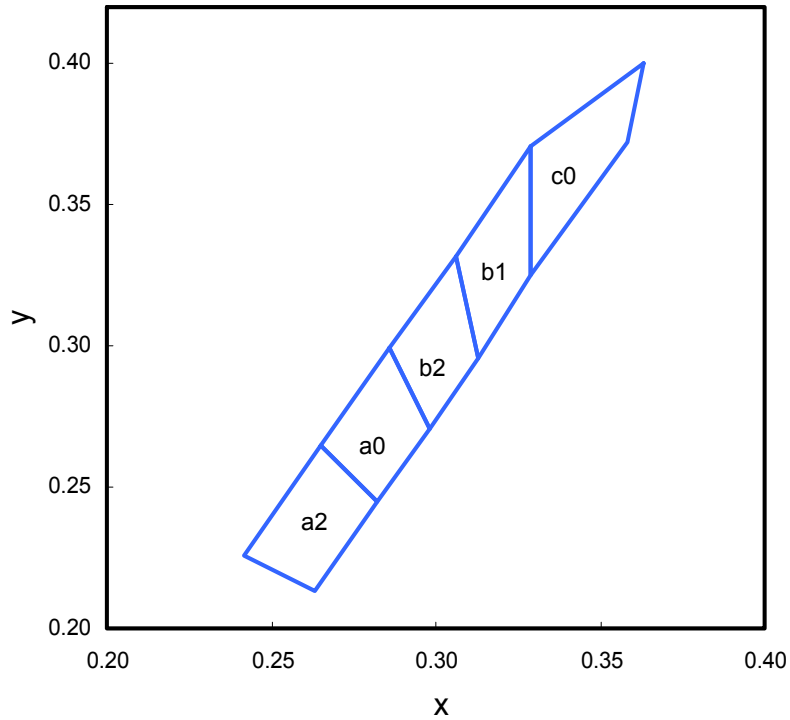

	x	y		x	y		x	y
a2	0.263	0.213	a0	0.282	0.245	b2	0.298	0.271
	0.282	0.245		0.298	0.271		0.313	0.296
	0.265	0.265		0.286	0.299		0.306	0.332
	0.242	0.226		0.265	0.265		0.286	0.299
b1	0.313	0.296	c0	0.329	0.325			
	0.329	0.325		0.358	0.372			
	0.329	0.371		0.363	0.400			
	0.306	0.332		0.329	0.371			

Notes:  
 Shipment may contain more than one chromaticity regions.  
 Orders for single chromaticity region are generally not accepted.  
 Measurement tolerance of the chromaticity coordinates is  $\pm 0.01$ .

## APTB1612CGKQWDF

Reflow soldering is recommended and the soldering profile is shown below.  
Other soldering methods are not recommended as they might cause damage to the product.

Reflow Soldering Profile For Lead-free SMT Process.

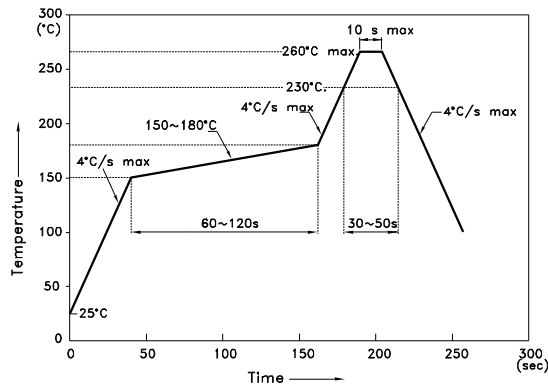

NOTES:

1. We recommend the reflow temperature 245°C(+/-5°C). The maximum soldering temperature should be limited to 260°C.
2. Don't cause stress to the epoxy resin while it is exposed to high temperature.
3. Number of reflow process shall be 2 times or less.

### Recommended Soldering Pattern (Units : mm; Tolerance: ± 0.1)

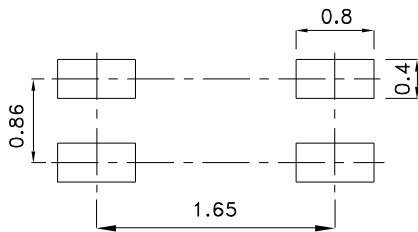

### Reel Dimension

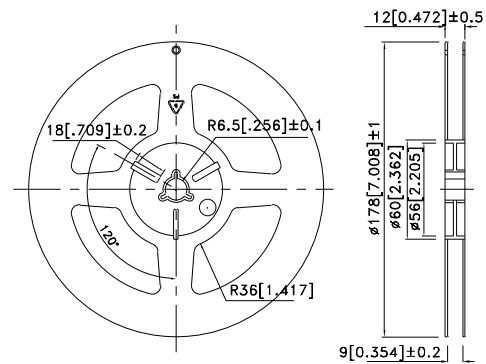

### Tape Dimensions (Units : mm)

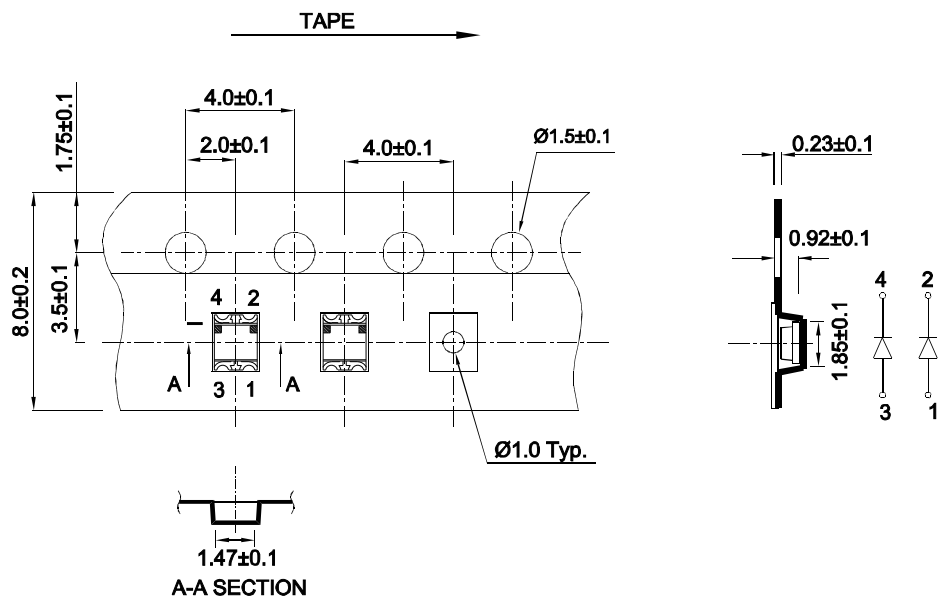

## PACKING & LABEL SPECIFICATIONS

APTB1612CGKQWDF

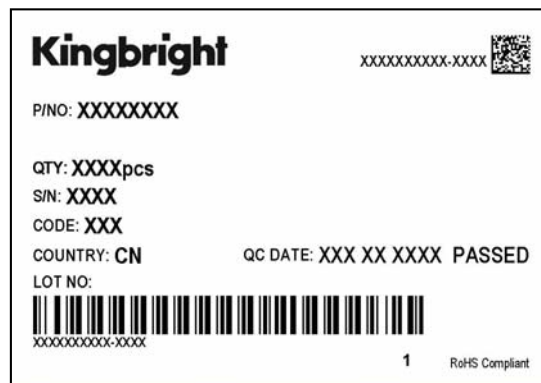
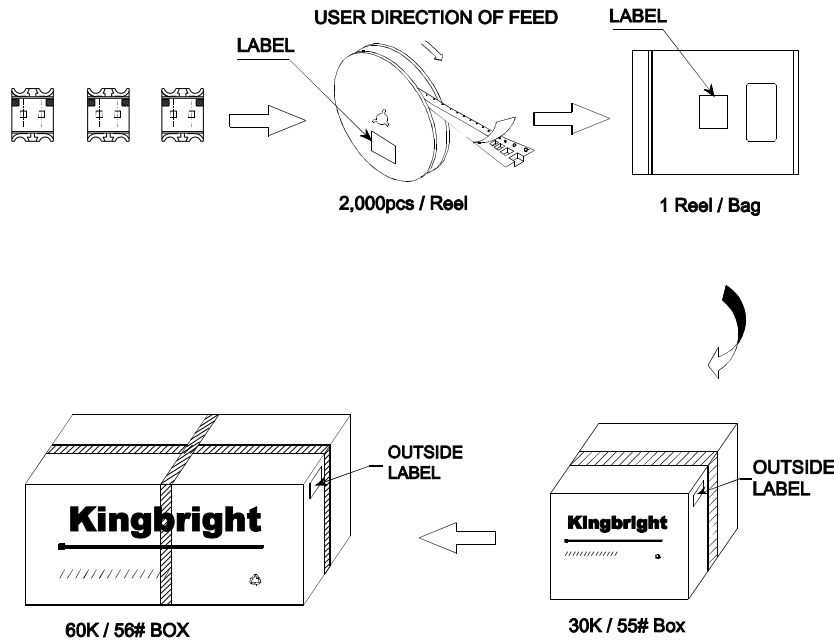

### Terms and conditions for the usage of this document

1. The information included in this document reflects representative usage scenarios and is intended for technical reference only.
2. The part number, type, and specifications mentioned in this document are subject to future change and improvement without notice. Before production usage customer should refer to the latest datasheet for the updated specifications.
3. When using the products referenced in this document, please make sure the product is being operated within the environmental and electrical limits specified in the datasheet. If customer usage exceeds the specified limits, Kingbright will not be responsible for any subsequent issues.
4. The information in this document applies to typical usage in consumer electronics applications. If customer's application has special reliability requirements or have life-threatening liabilities, such as automotive or medical usage, please consult with Kingbright representative for further assistance.
5. The contents and information of this document may not be reproduced or re-transmitted without permission by Kingbright.
6. All design applications should refer to Kingbright application notes available at <http://www.KingbrightUSA.com/ApplicationNotes>