



ATTENTION
OBSERVE PRECAUTIONS
FOR HANDLING
ELECTROSTATIC
DISCHARGE
SENSITIVE
DEVICES

Part Number: APF3236SURKZGQBDC

Hyper Red
Green
Blue

Features

- 3.2mmx3.6mm SMT LED, 1.1mm thickness.
- Low power consumption.
- One red, one green and one blue chips in one package.
- Package : 1000pcs / reel.
- Moisture sensitivity level : level 3.
- RoHS compliant.

Description

The Hyper Red source color devices are made with Al-GaN on GaAs substrate Light Emitting Diode.

The Green source color devices are made with InGaN on Sapphire Light Emitting Diode.

The Blue source color devices are made with InGaN on Sapphire Light Emitting Diode.

Static electricity and surge damage the LEDs.

It is recommended to use a wrist band or anti-electrostatic glove when handling the LEDs.

All devices, equipment and machinery must be electrically grounded.

Package Dimensions

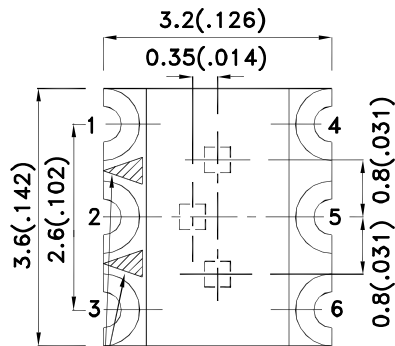

POLARITY MARK

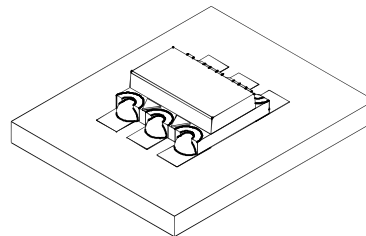
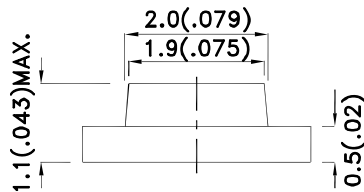
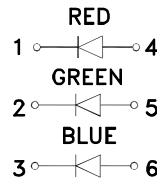

Notes:

1. All dimensions are in millimeters (inches).
2. Tolerance is $\pm 0.2(0.008)$ unless otherwise noted.
3. The specifications, characteristics and technical data described in the datasheet are subject to change without prior notice.
4. The device has a single mounting surface. The device must be mounted according to the specifications.



Selection Guide

Part No.	Dice	Lens Type	Iv (mcd) [2] @ 20mA		Viewing Angle [1]
			Min.	Typ.	2θ1/2
APF3236SURKZGQBDC	Hyper Red (AlGaInP)	Water Clear	80	140	120°
	Green (InGaN)		200	330	
	Blue (InGaN)		40	70	

Notes:

1. θ1/2 is the angle from optical centerline where the luminous intensity is 1/2 of the optical peak value.
2. Luminous intensity/ luminous Flux: +/-15%.
3. Luminous intensity value is traceable to the CIE127-2007 compliant national standards.

Electrical / Optical Characteristics at TA=25°C

Symbol	Parameter	Device	Typ.	Max.	Units	Test Conditions
λpeak	Peak Wavelength	Hyper Red Green Blue	630 515 468		nm	If=20mA
λD [1]	Dominant Wavelength	Hyper Red Green Blue	621 525 470		nm	If=20mA
Δλ1/2	Spectral Line Half-width	Hyper Red Green Blue	20 30 25		nm	If=20mA
C	Capacitance	Hyper Red Green Blue	25 45 100		pF	Vf=0V;f=1MHz
Vf [2]	Forward Voltage	Hyper Red Green Blue	2 3.3 3.3	2.5 4.1 4	V	If=20mA
IR	Reverse Current	Hyper Red Green Blue		10 50 50	uA	VR=5V

Notes:

- 1.Wavelength: +/-1nm.
2. Forward Voltage: +/-0.1V.
- 3.Wavelength value is traceable to the CIE127-2007 compliant national standards.

Absolute Maximum Ratings at TA=25°C

Parameter	Hyper Red	Green	Blue	Units
Power dissipation	75	102.5	120	mW
DC Forward Current	30	25	30	mA
Peak Forward Current [1]	195	150	150	mA
Reverse Voltage	5			V
Operating Temperature	-40°C To +85°C			
Storage Temperature	-40°C To +85°C			

Notes:

1. 1/10 Duty Cycle, 0.1ms Pulse Width.

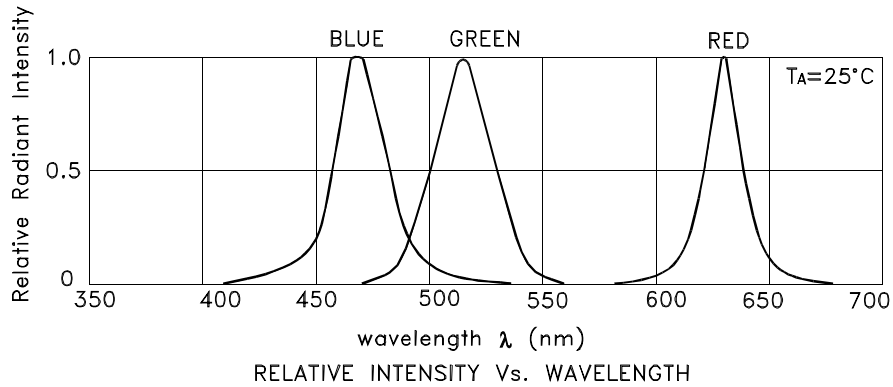

APF3236SURKZGQBDC Hyper Red

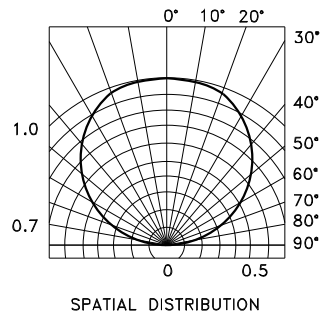
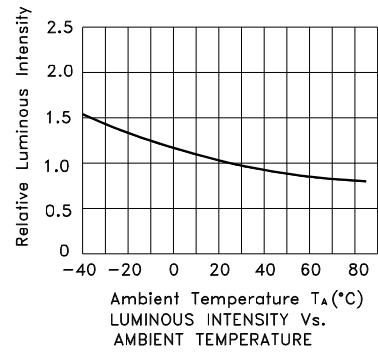
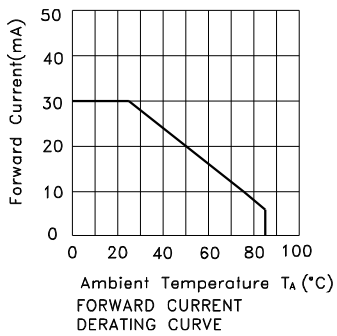
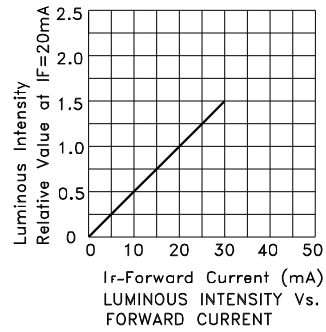
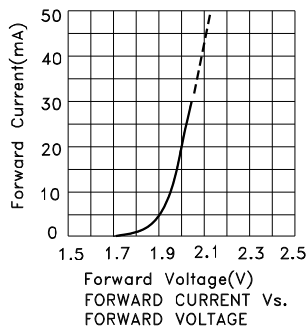

Green

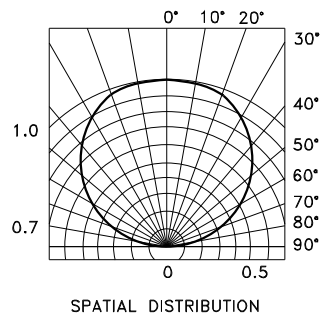
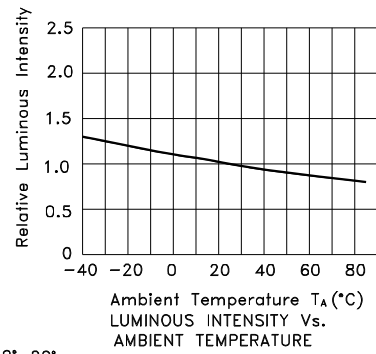
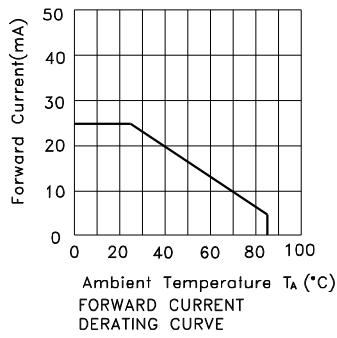
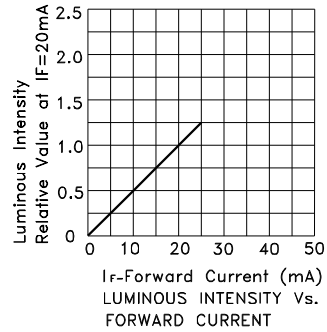
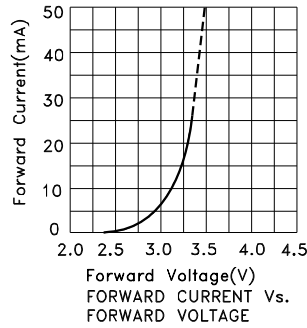

Kingbright

Blue

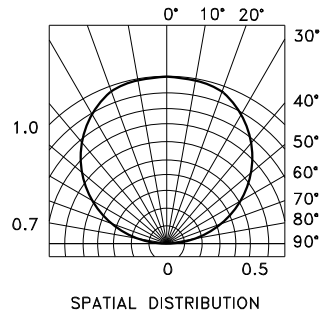
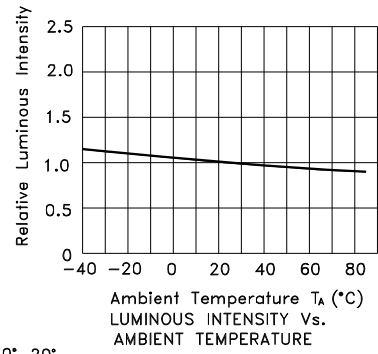
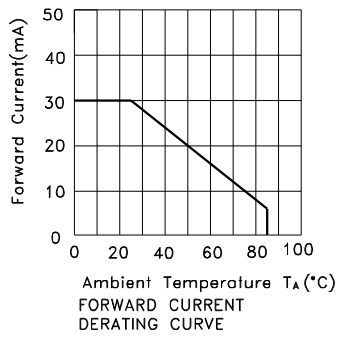
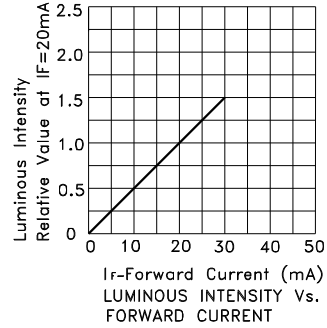
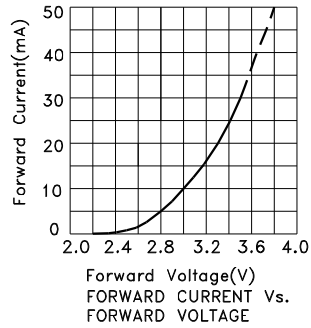

APF3236SURKZGQBC

Reflow soldering is recommended and the soldering profile is shown below.
Other soldering methods are not recommended as they might cause damage to the product.

Reflow Soldering Profile For Lead-free SMT Process.

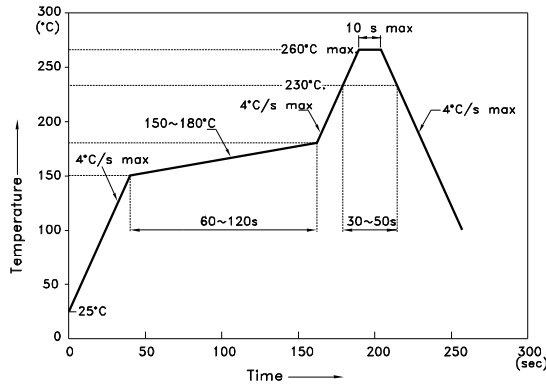

NOTES:

1. We recommend the reflow temperature 245°C(+/-5°C). The maximum soldering temperature should be limited to 260°C.
2. Don't cause stress to the epoxy resin while it is exposed to high temperature.
3. Number of reflow process shall be 2 times or less.

Recommended Soldering Pattern (Units : mm; Tolerance: ± 0.1)

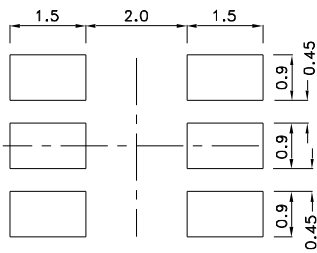

Reel Dimension

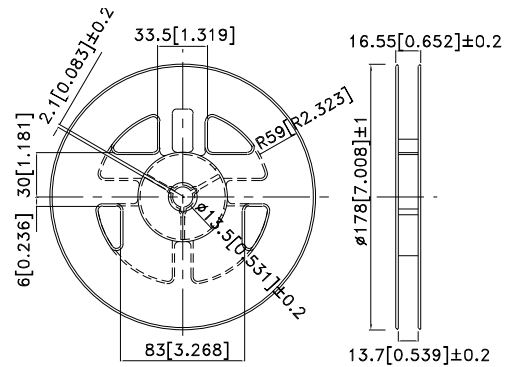

Tape Dimensions (Units : mm)

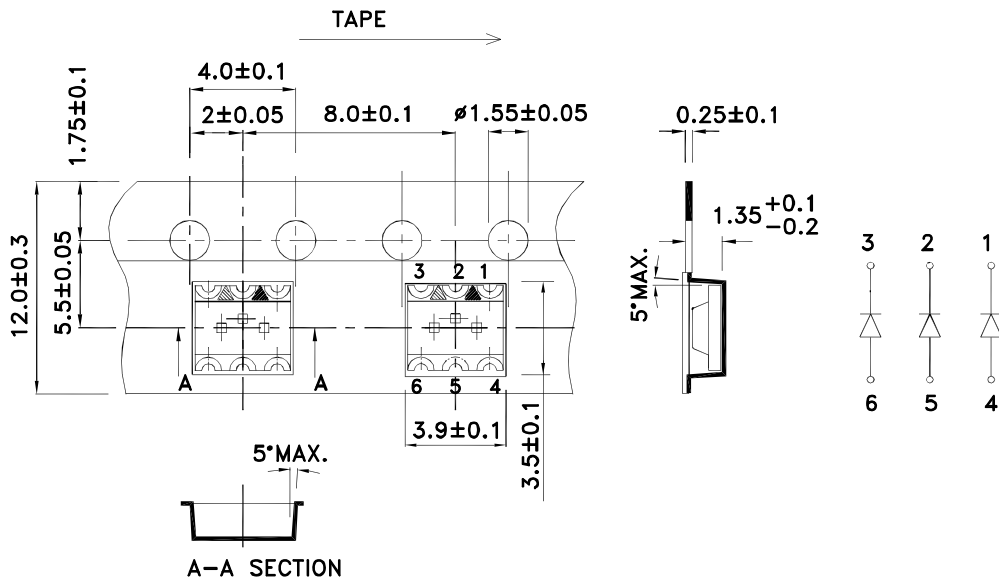

Kingbright

PACKING & LABEL SPECIFICATIONS

APF3236SURKZGQBDC

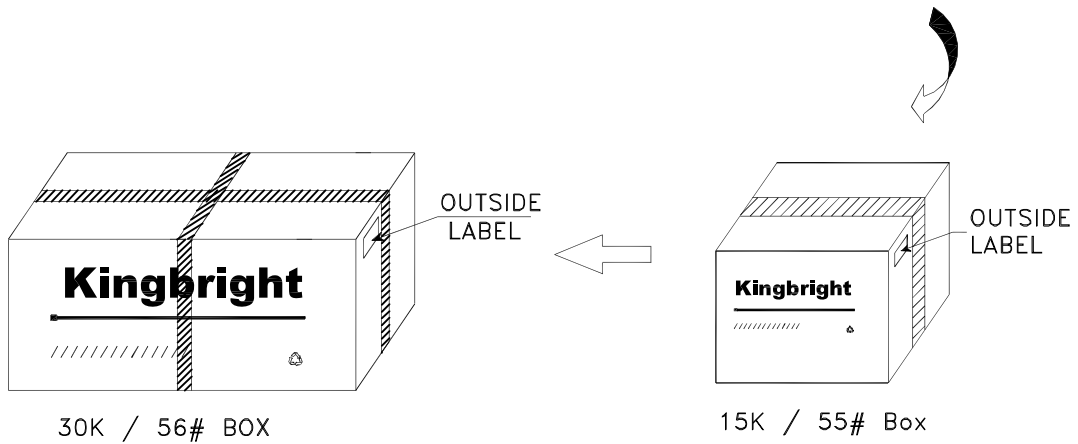
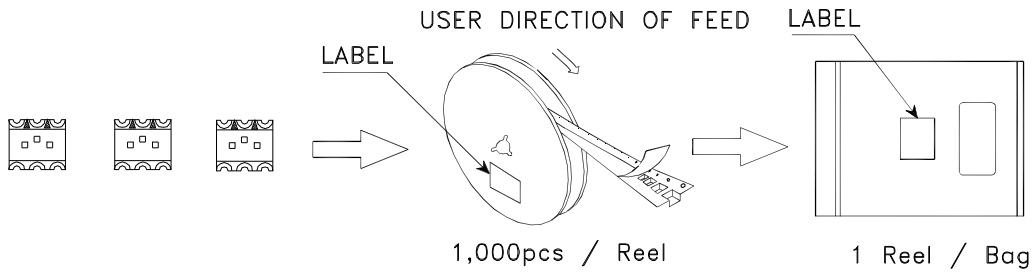

<h2>Kingbright</h2>	
P/NO: APF3236xxx	
QTY: 1,000 pcs	Q.C. Q C XX XX XXXX PASSED
S/N: XXXX	
CODE: XXX	
LOT NO:	
 XXXXXXXXXXXXXXXXXXXXXXXX	
RoHS Compliant	