

### PRELIMINARY SPEC

Part Number: AAAF5051-02



**ATTENTION**  
OBSERVE PRECAUTIONS  
FOR HANDLING  
ELECTROSTATIC  
DISCHARGE  
SENSITIVE  
DEVICES

Blue  
Reddish-Orange  
Green

### Features

- Chips can be controlled separately.
- Suitable for all SMT assembly and solder process.
- Available on tape and reel.
- White SMD package, silicone resin.
- Package: 500pcs / reel.
- Moisture sensitivity level : level 3.
- RoHS compliant.

### Description

The Blue source color devices are made with AlGaInN Vertical Light Emitting Diode.

This devices are made with AlGaInP.

The Green source color devices are made with AlGaInN Vertical Light Emitting Diode.

Static electricity and surge damage the LEDs.

It is recommended to use a wrist band or anti-electrostatic glove when handling the LEDs.

All devices, equipment and machinery must be electrically grounded.

### Package Dimensions

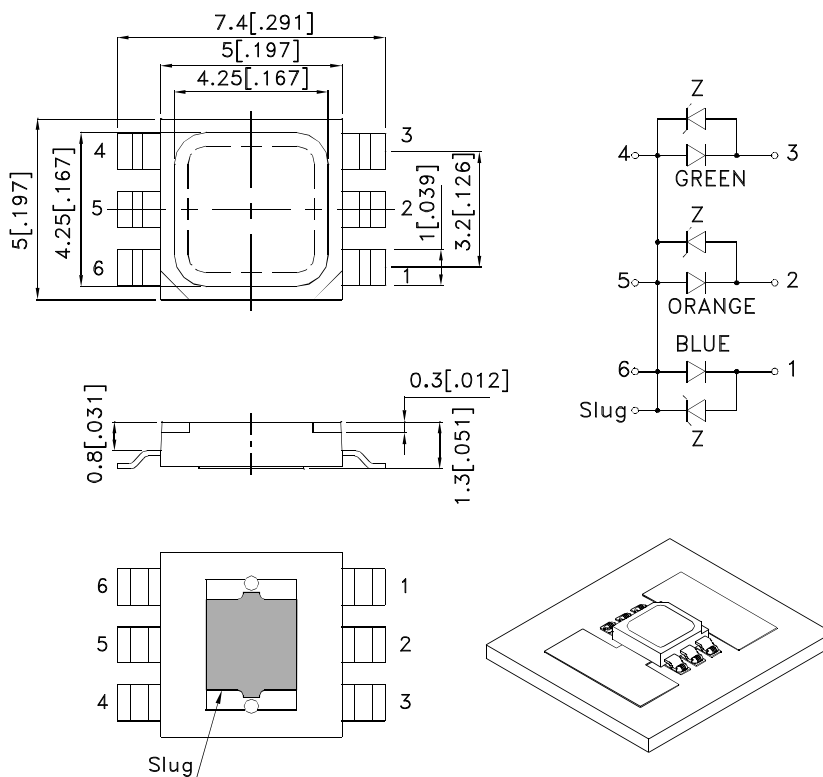

#### Notes:

1. All dimensions are in millimeters (inches).
2. Tolerance is  $\pm 0.15$  [ $\pm 0.006$ ] unless otherwise noted.
3. Specifications are subject to change without notice.
4. The device has a single mounting surface. The device must be mounted according to the specifications.



## Handling Precautions

Compare to epoxy encapsulant that is hard and brittle, silicone is softer and flexible. Although its characteristic significantly reduces thermal stress, it is more susceptible to damage by external mechanical force.

As a result, special handling precautions need to be observed during assembly using silicone encapsulated LED products. Failure to comply might leads to damage and premature failure of the LED.

1. Handle the component along the side surfaces by using forceps or appropriate tools.

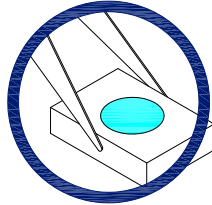

2. Do not directly touch or handle the silicone lens surface. It may damage the internal circuitry.

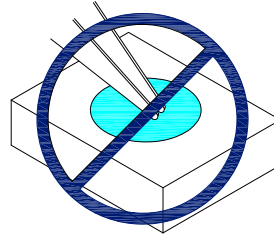
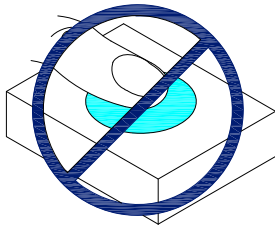

3. Do not stack together assembled PCBs containing exposed LEDs. Impact may scratch the silicone lens or damage the internal circuitry.

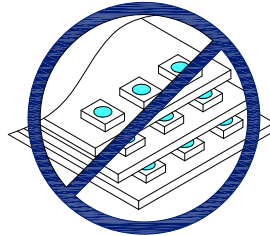

4. The outer diameter of the SMD pickup nozzle should not exceed the size of the LED to prevent air leaks. The inner diameter of the nozzle should be as large as possible.
5. A pliable material is suggested for the nozzle tip to avoid scratching or damaging the LED surface during pickup.
6. The dimensions of the component must be accurately programmed in the pick-and-place machine to insure precise pickup and avoid damage during production.

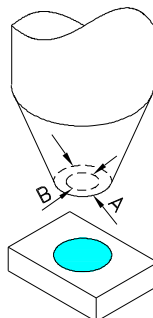

## Selection Guide

Part No.	Dice	Lens Type	Iv (mcd) [2] @ 120mA		Φv (mlm) [2] @ 120mA		Viewing Angle [1]
			Min.	Typ.	Min.	Typ.	2θ1/2
AAAF5051-02	Blue (AlGaInN)	WATER CLEAR	900	1450	5000	6300	120°
	Reddish-Orange (AlGaInP)		2500	4000	8000	9000	
	Green (AlGaInN)		3800	4900	12500	17000	

**Notes:**

1. θ1/2 is the angle from optical centerline where the luminous intensity is 1/2 the optical centerline value.
2. Luminous intensity/ luminous Flux: +/-15%.

## Absolute Maximum Ratings at Ta=25°C

Parameter	Symbol	Device	Value	Unit
Power dissipation	Pt	Blue	0.432	W
		Reddish-Orange	0.336	
		Green	0.444	
Junction temperature	Tj	Blue	110	°C
		Reddish-Orange	110	
		Green	110	
Operating Temperature	Top	Blue	-40 To +85	°C
		Reddish-Orange		
		Green		
Storage Temperature	Tstg	Blue	-40 To +85	°C
		Reddish-Orange		
		Green		
DC Forward Current [1]	If	Blue	120	mA
		Reddish-Orange	120	
		Green	120	
Peak Forward Current [2]	IFM	Blue	300	mA
		Reddish-Orange	300	
		Green	300	
Thermal resistance	Rth j-a	Blue	220	°C/W
		Reddish-Orange	270	
		Green	200	
Electrostatic Discharge Threshold (HBM)		Blue	8000	V
		Reddish-Orange		
		Green		

**Notes:**

1. Results from mounting on PC board FR4(pad size ≥ 100mm<sup>2</sup> ),mounted on pc board-metal core PCB is recommend for lowest thermal resistance.
2. 1/10 Duty Cycle, 0.1ms Pulse Width.

## Electrical / Optical Characteristics at $T_a=25^{\circ}\text{C}$

Parameter	Symbol	Device	Value			Unit
			Min.	Typ.	Max.	
Wavelength at peak emission $I_F=120\text{mA}$	$\lambda_{\text{peak}}$	Blue		450		nm
		Reddish-Orange		633		
		Green		515		
Dominant Wavelength $I_F=120\text{mA}$	$\lambda_{\text{dom}} [1]$	Blue		457		nm
		Reddish-Orange		624		
		Green		525		
Spectral Line Half-width $I_F=120\text{mA}$	$\Delta\lambda_{1/2}$	Blue		20		nm
		Reddish-Orange		30		
		Green		30		
Forward Voltage $I_F=120\text{mA}$	$V_F [2]$	Blue	2.6	3.1	3.6	V
		Reddish-Orange	1.8	2.3	2.8	
		Green	2.6	3.2	3.7	
Temperature coefficient of $\lambda_{\text{peak}}$ $I_F=120\text{mA}, -10^{\circ}\text{C} \leq T \leq 100^{\circ}\text{C}$	$\text{TC } \lambda_{\text{peak}}$	Blue		0.12		$\text{nm}/^{\circ}\text{C}$
		Reddish-Orange		0.09		
		Green		0.13		
Temperature coefficient of $\lambda_{\text{dom}}$ $I_F=120\text{mA}, -10^{\circ}\text{C} \leq T \leq 100^{\circ}\text{C}$	$\text{TC } \lambda_{\text{dom}}$	Blue		0.1		$\text{nm}/^{\circ}\text{C}$
		Reddish-Orange		0.03		
		Green		0.11		
Temperature coefficient of $V_F$ $I_F=120\text{mA}, -10^{\circ}\text{C} \leq T \leq 100^{\circ}\text{C}$	$\text{TC}_V$	Blue		-2.3		$\text{mV}/^{\circ}\text{C}$
		Reddish-Orange		-2.7		
		Green		-3.9		

Notes:

1. Wavelength:  $\pm 1\text{nm}$ .
2. Forward Voltage:  $\pm 0.1\text{V}$ .

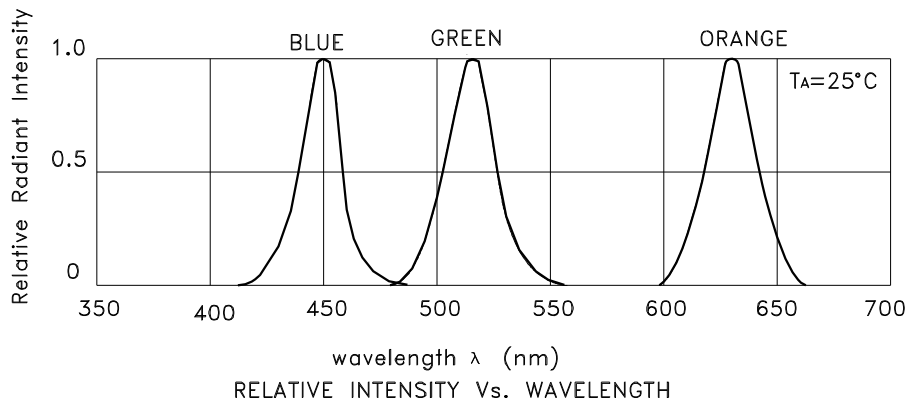

## AAAF5051-02 Blue

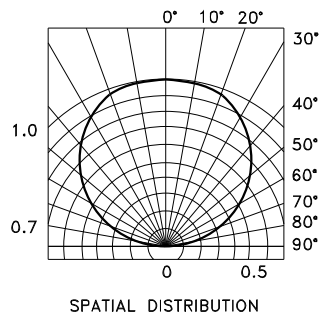
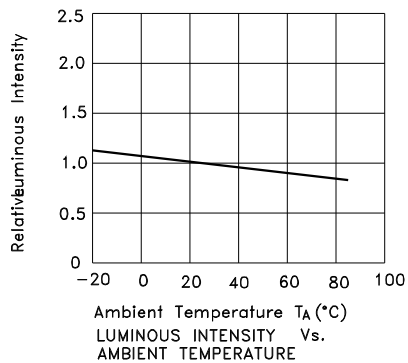
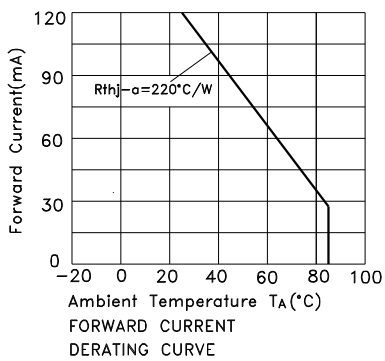
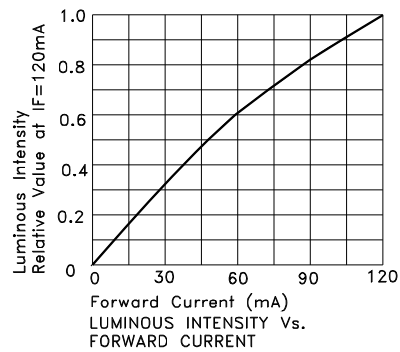
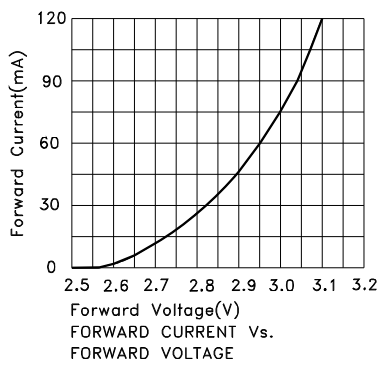

## Reddish-Orange

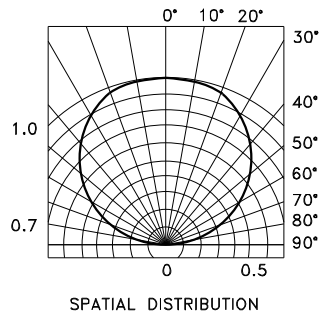
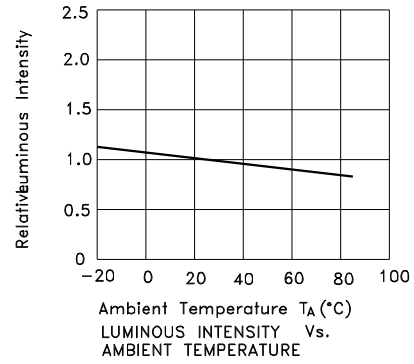
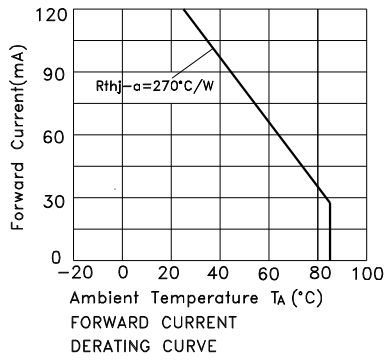
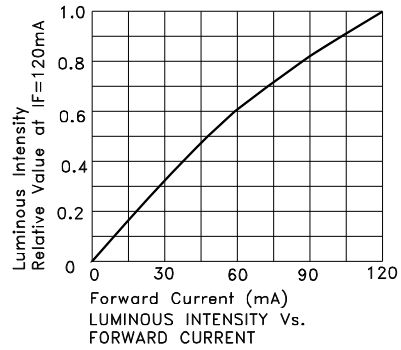
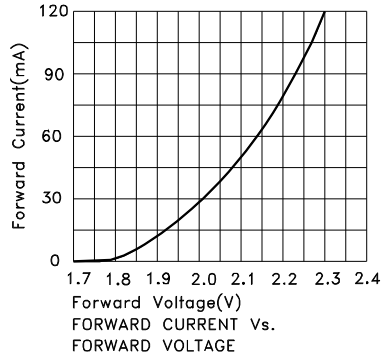

# Kingbright

## Green

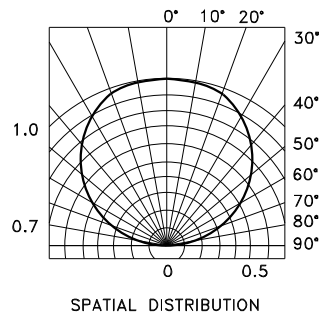
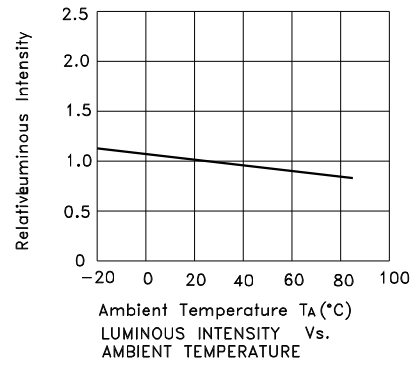
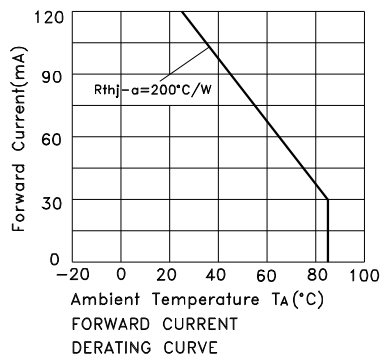
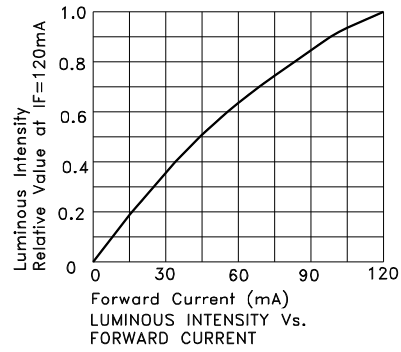
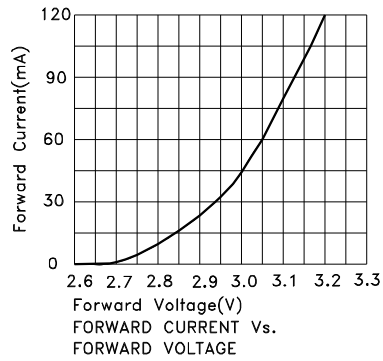

## AAAF5051-02

Reflow soldering is recommended and the soldering profile is shown below.  
Other soldering methods are not recommended as they might cause damage to the product.

Reflow Soldering Profile For Lead-free SMT Process.

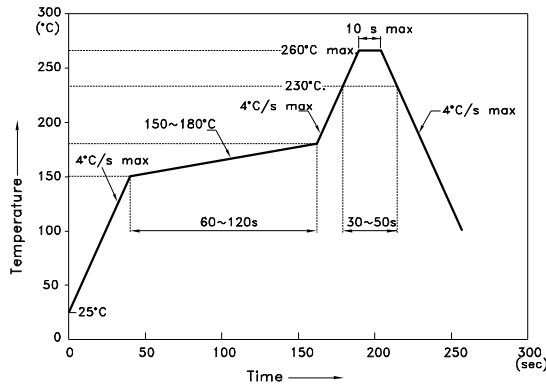

NOTES:

1. We recommend the reflow temperature 245°C(+/-5°C). The maximum soldering temperature should be limited to 260°C.
2. Don't cause stress to the epoxy resin while it is exposed to high temperature.
3. Number of reflow process shall be 2 times or less.

### Recommended Soldering Pattern (Units : mm; Tolerance: ± 0.1)

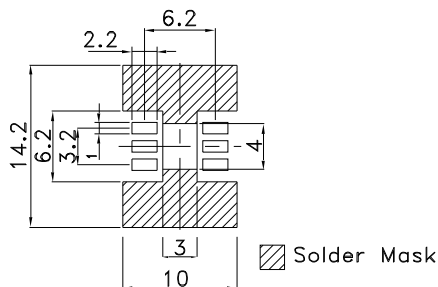

### Tape Specifications (Units : mm)

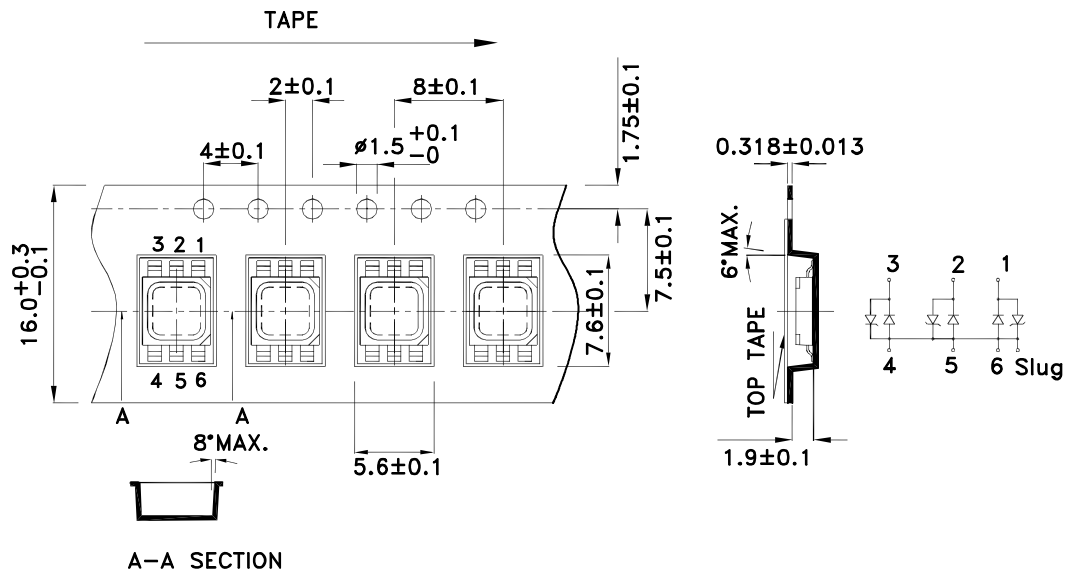



**PACKING & LABEL SPECIFICATIONS**

**AAAF5051-02**

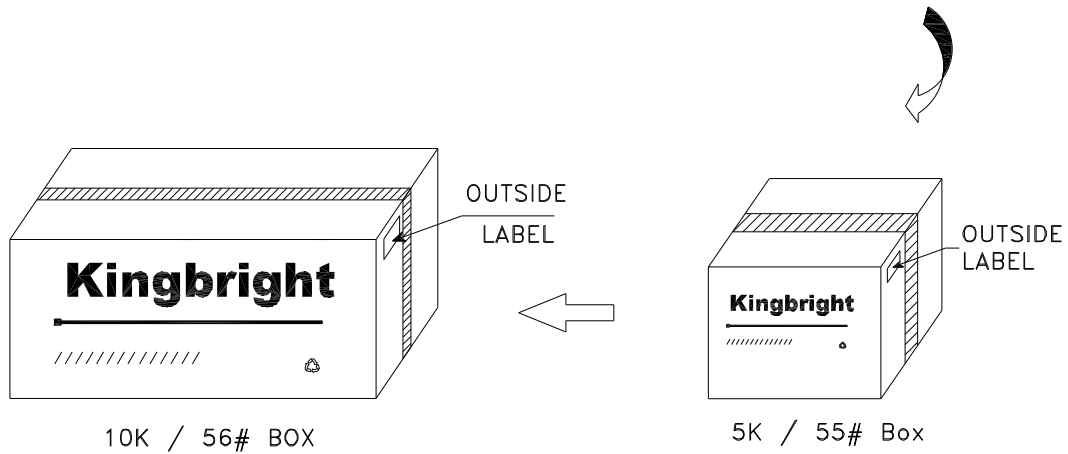
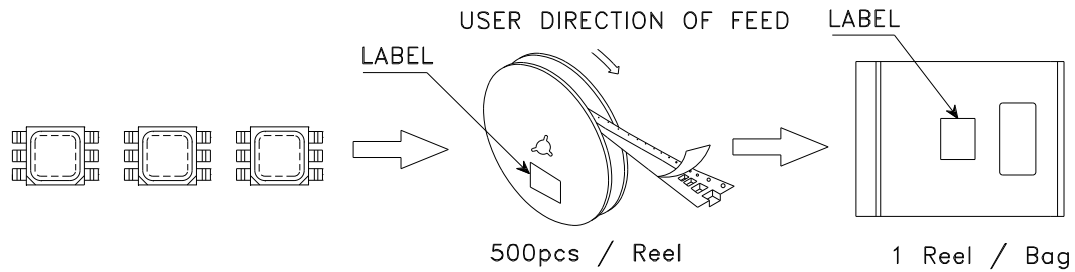

<h2 style="margin: 0;">Kingbright</h2>				
P/NO: AAAF5051xxx				
QTY: 500 pcs	Q.C.			
S/N: XXXX	<table border="1" style="margin: auto; border-collapse: collapse;"> <tr> <td style="text-align: center;">Q C</td> </tr> <tr> <td style="text-align: center;">XX XX XXXX</td> </tr> <tr> <td style="text-align: center;">PASSED</td> </tr> </table>	Q C	XX XX XXXX	PASSED
Q C				
XX XX XXXX				
PASSED				
CODE: XXX				
LOT NO:				
<small>XXXXXXXXXXXXXXXXXXXXXXXXXXXX</small>				
RoHS Compliant				