

Part Number: AA3535QB25Z1S      Blue



**ATTENTION**  
OBSERVE PRECAUTIONS  
FOR HANDLING  
ELECTROSTATIC  
DISCHARGE  
SENSITIVE  
DEVICES

### Features

- White SMD package, silicone resin.
- Low thermal resistance.
- Compatible with IR-reflow processes.
- ESD protection.
- Package: 2000pcs / reel.
- Moisture sensitivity level : level 2a.
- RoHS compliant.

### Description

The Blue source color devices are made with InGaN on Al<sub>2</sub>O<sub>3</sub> substrate Light Emitting Diode.

Static electricity and surge damage the LEDs.

It is recommended to use a wrist band or anti-electrostatic glove when handling the LEDs.

All devices, equipment and machinery must be electrically grounded.

### Applications

- Signal and symbol luminaire for orientation.
- Marker lights (e.g. steps, exit ways, etc).
- Decorative and entertainment lighting.
- Commercial and residential lighting.
- Automotive interior lighting.

### Package Dimensions

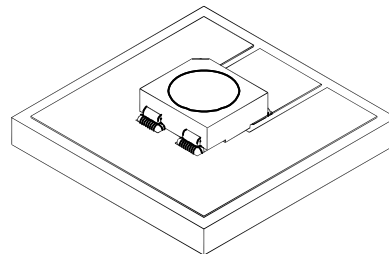
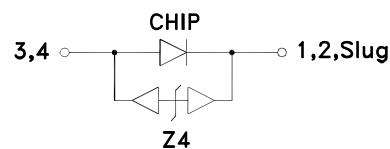
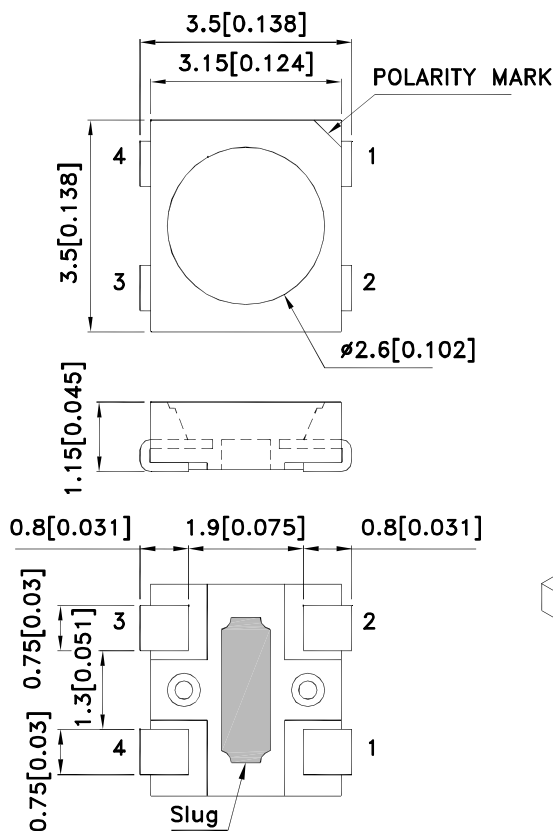

#### Notes:

1. All dimensions are in millimeters (inches).
2. Tolerance is  $\pm 0.25(0.01)$  unless otherwise noted.
3. The specifications, characteristics and technical data described in the datasheet are subject to change without prior notice.
4. The device has a single mounting surface. The device must be mounted according to the specifications.

## Handling Precautions

Compare to epoxy encapsulant that is hard and brittle, silicone is softer and flexible. Although its characteristic significantly reduces thermal stress, it is more susceptible to damage by external mechanical force.

As a result, special handling precautions need to be observed during assembly using silicone encapsulated LED products. Failure to comply might lead to damage and premature failure of the LED.

1. Handle the component along the side surfaces by using forceps or appropriate tools.

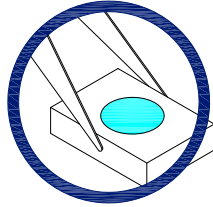

2. Do not directly touch or handle the silicone lens surface. It may damage the internal circuitry.

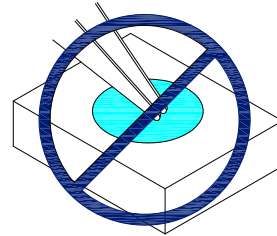
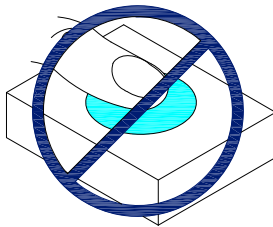

3. Do not stack together assembled PCBs containing exposed LEDs. Impact may scratch the silicone lens or damage the internal circuitry.

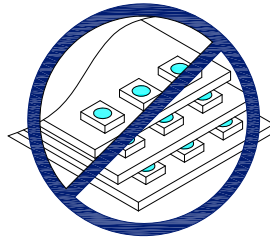

- 4.1. The inner diameter of the SMD pickup nozzle should not exceed the size of the LED to prevent air leaks.
- 4.2. A pliable material is suggested for the nozzle tip to avoid scratching or damaging the LED surface during pickup.
- 4.3. The dimensions of the component must be accurately programmed in the pick-and-place machine to insure precise pickup and avoid damage during production.

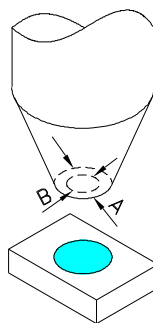

5. As silicone encapsulation is permeable to gases, some corrosive substances such as H<sub>2</sub>S might corrode silver plating of leadframe. Special care should be taken if an LED with silicone encapsulation is to be used near such substances.

## Selection Guide

Part No.	Dice	Lens Type	Iv (cd) [2] @ 150mA		Φv (lm) [2] @ 150mA*		Viewing Angle [1]
			Min.	Typ.	Min.	Typ.	2 θ 1/2
AA3535QB25Z1S	Blue (InGaN)	Water Clear	0.7	1.3	2.4	3.5	120 °

Notes:

1. θ1/2 is the angle from optical centerline where the luminous intensity is 1/2 of the optical peak value.
2. Luminous intensity/ luminous Flux: +/-15%.\*LEDs are binned according to their luminous flux.

## Absolute Maximum Ratings at TA=25°C

Parameter	Symbol	Value	Unit
Power Dissipation	P <sub>D</sub>	600	mW
Junction Temperature [1]	T <sub>J</sub>	130	°C
Operating Temperature	T <sub>op</sub>	-40 To +85	°C
Storage Temperature	T <sub>stg</sub>	-40 To +85	°C
DC Forward Current [1]	I <sub>F</sub>	150	mA
Peak Forward Current [2]	I <sub>FM</sub>	300	mA
Reverse Voltage	V <sub>R</sub>	5	V
Thermal Resistance [1] (Junction/ambient)	R <sub>th j-a</sub>	200	°C/W
Thermal Resistance [1] (Junction/solder point)	R <sub>th j-s</sub>	98	°C/W
Electrostatic Discharge Threshold (HBM)		8000	V

Notes:

1. Results from mounting on PC board FR4 (pad size ≥ 70mm<sup>2</sup>), mounted on pc board-metal core PCB is recommend for lowest thermal Resistance.
2. 1/10 Duty Cycle, 0.1ms Pulse Width.

## Electrical / Optical Characteristics at TA=25°C

Parameter	Symbol	Value	Unit
Wavelength at peak emission I <sub>F</sub> =150mA [Typ.]	λ peak	445	nm
Dominant Wavelength I <sub>F</sub> =150mA [Typ.]	λ dom [1]	450	nm
Spectral Line Half-width I <sub>F</sub> =150mA [Typ.]	Δλ	20	nm
Forward Voltage I <sub>F</sub> =150mA [Min.]	V <sub>F</sub> [2]	2.7	V
Forward Voltage I <sub>F</sub> =150mA [Typ.]		3.5	
Forward Voltage I <sub>F</sub> =150mA [Max.]		4.0	
Allowable Reverse Current [Max.]	I <sub>R</sub>	85	mA
Temperature coefficient of λ peak I <sub>F</sub> =150mA, -10 ° C ≤ T ≤ 100 ° C [Typ.]	TC λ peak	0.12	nm/° C
Temperature coefficient of λ dom I <sub>F</sub> =150mA, -10 ° C ≤ T ≤ 100 ° C [Typ.]	TC λ dom	0.1	nm/° C
Temperature coefficient of V <sub>F</sub> I <sub>F</sub> =150mA, -10 ° C ≤ T ≤ 100 ° C [Typ.]	TC <sub>V</sub>	-2.3	mV/° C

Notes:

1. Wavelength: +/-1nm.
2. Forward Voltage: +/-0.1V.

# Kingbright

Blue

AA3535QB25Z1S

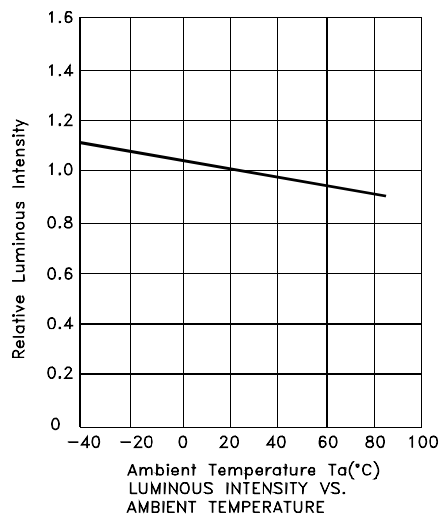
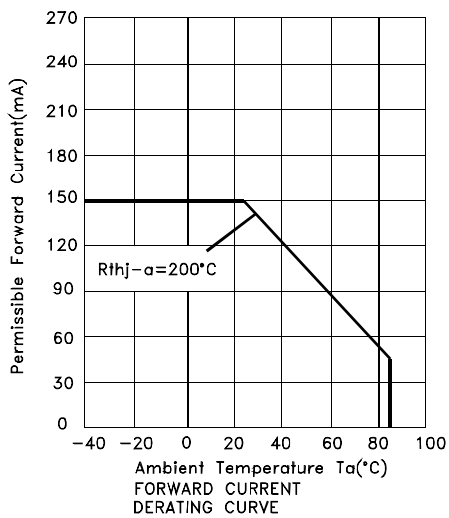
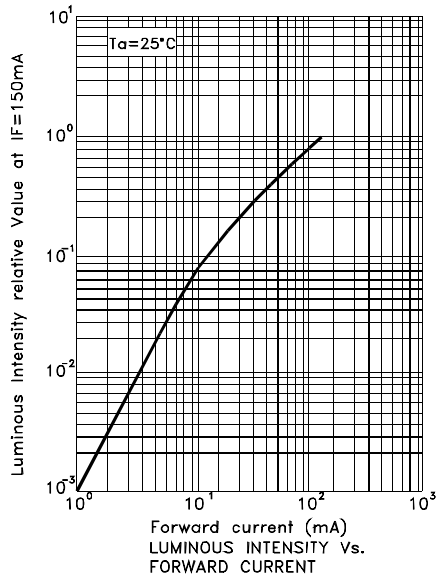
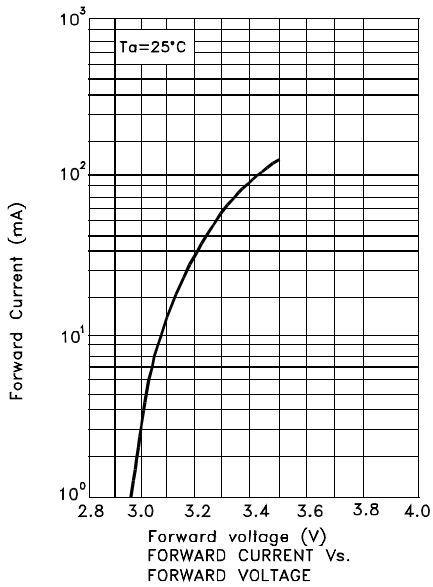
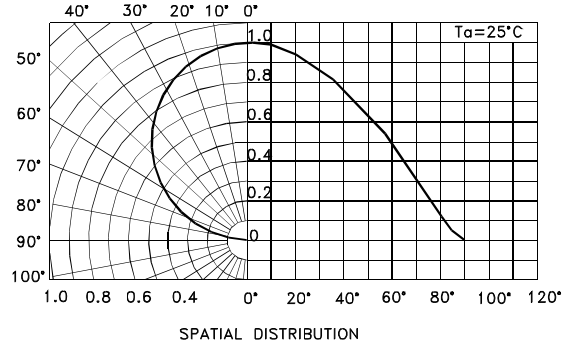
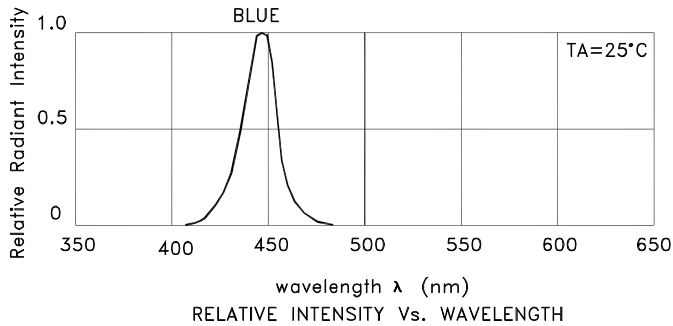



**PACKING & LABEL SPECIFICATIONS**

**AA3535QB25Z1S**

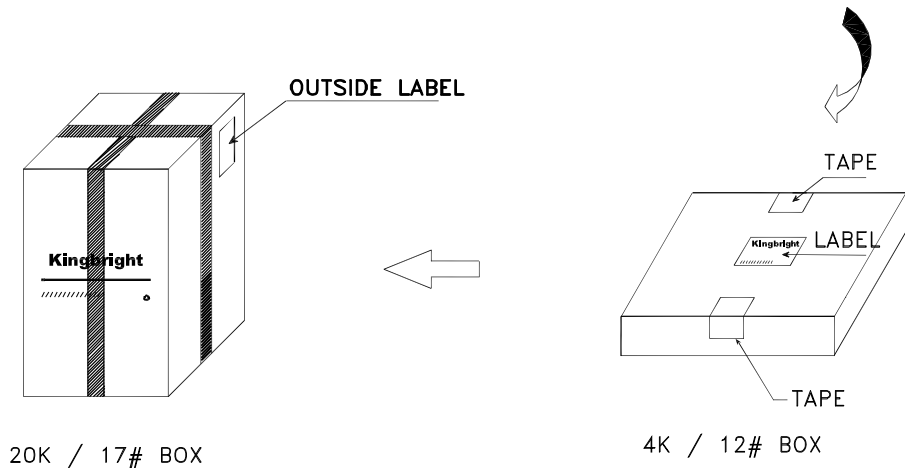
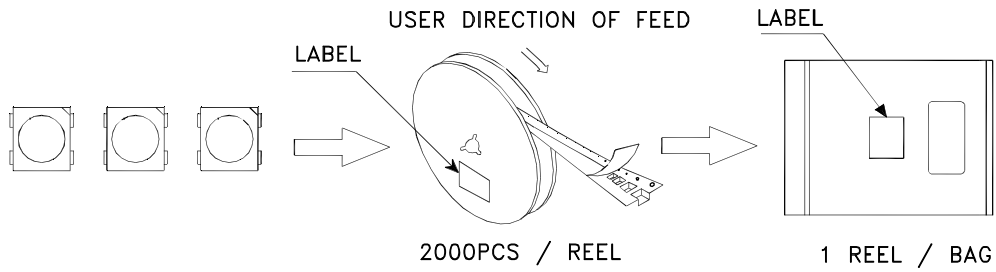

<h1>Kingbright</h1>		
P/N0: AA3535xxx		
QTY: 2000 pcs	Q.C.	Q C xx xx xxxx PASSED
S/N: XXXX		
CODE: XXX		
LOT NO:		
 xxxxxxxxxxxxxxxxxxxxxxxxxxxx		
RoHS Compliant		