

Part Number: APHM1608YCT

Yellow

Features

- 1.6mmx0.8mm SMD LED, 0.45mm max. thickness.
- Low power consumption.
- Wide viewing angle.
- Ideal for backlight and indicator.
- Package : 2000pcs / reel.
- Moisture sensitivity level : level 3.
- RoHS compliant.

Description

The Yellow source color devices are made with Gallium Arsenide Phosphide on Gallium Phosphide Yellow Light Emitting Diode.

Package Dimensions

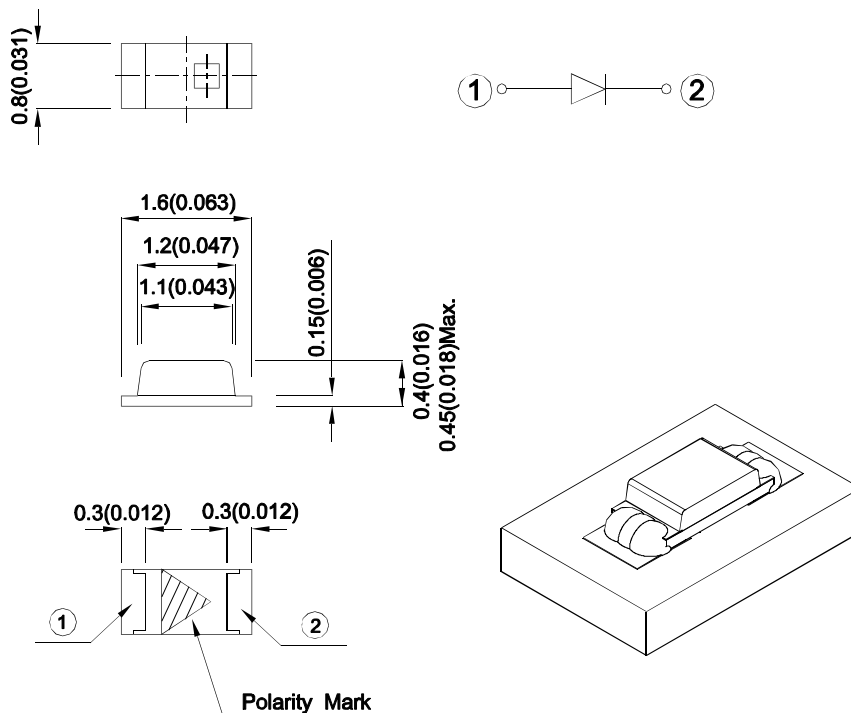

Notes:

1. All dimensions are in millimeters (inches).
2. Tolerance is $\pm 0.1(0.004)$ unless otherwise noted.
3. The specifications, characteristics and technical data described in the datasheet are subject to change without prior notice.
4. The device has a single mounting surface. The device must be mounted according to the specifications.



Selection Guide

Part No.	Emitting Color (Material)	Lens Type	Iv (mcd) [2] @ 20mA		Viewing Angle [1]
			Min.	Typ.	2θ1/2
APHM1608YCT	Yellow (GaAsP/GaP)	Water Clear	5	8	120°

Notes:

1. θ1/2 is the angle from optical centerline where the luminous intensity is 1/2 of the optical peak value.
2. Luminous intensity/ luminous Flux: +/-15%.
3. Luminous intensity value is traceable to the CIE127-2007 compliant national standards.

Electrical / Optical Characteristics at TA=25°C

Symbol	Parameter	Emitting Color	Typ.	Max.	Units	Test Conditions
λ _{peak}	Peak Wavelength	Yellow	590		nm	I _F =20mA
λ _D [1]	Dominant Wavelength	Yellow	588		nm	I _F =20mA
Δλ _{1/2}	Spectral Line Half-width	Yellow	35		nm	I _F =20mA
C	Capacitance	Yellow	20		pF	V _F =0V;f=1MHz
V _F [2]	Forward Voltage	Yellow	2.1	2.5	V	I _F =20mA
I _R	Reverse Current	Yellow		10	uA	V _R =5V

Notes:

- 1.Wavelength: +/-1nm.
- 2.Forward Voltage: +/-0.1V.
- 3.Wavelength value is traceable to the CIE127-2007 compliant national standards.
- 4.Excess driving current and/or operating temperature higher than recommended conditions may result in severe light degradation or premature failure.

Absolute Maximum Ratings at TA=25°C

Parameter	Values	Units
Power dissipation	75	mW
DC Forward Current	30	mA
Peak Forward Current [1]	140	mA
Reverse Voltage	5	V
Operating Temperature	-40°C To +85°C	
Storage Temperature	-40°C To +85°C	

Note:

1. 1/10 Duty Cycle, 0.1ms Pulse Width.

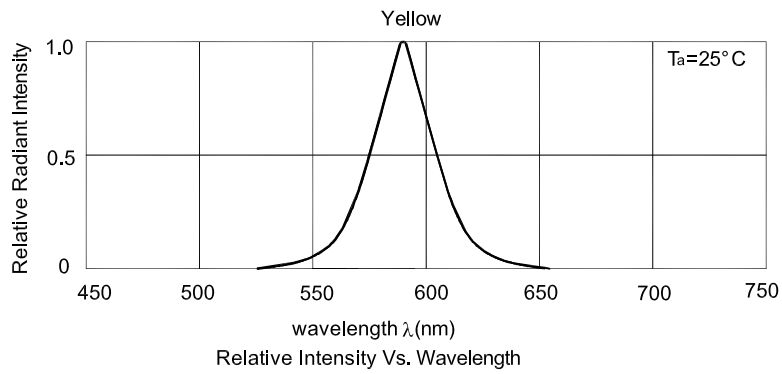

Yellow

APHM1608YCT

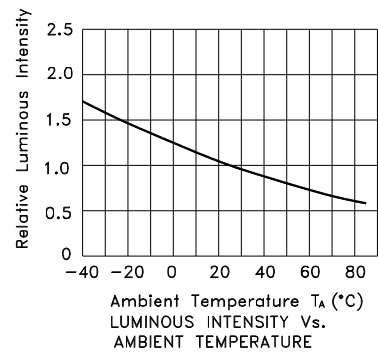
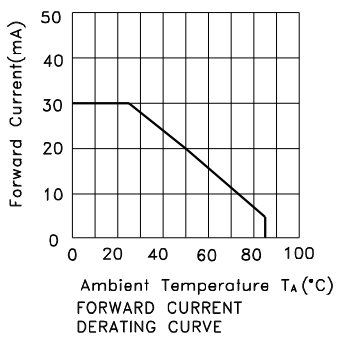
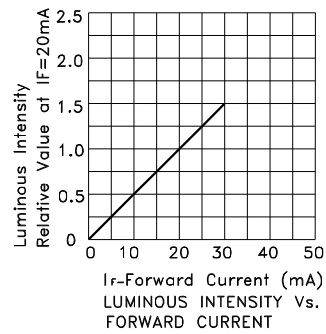
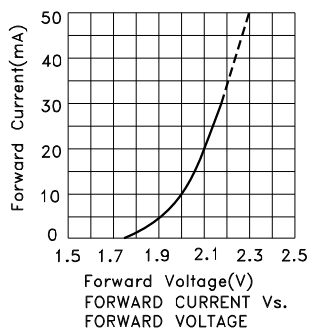

APHM1608YCT

Reflow soldering is recommended and the soldering profile is shown below.
Other soldering methods are not recommended as they might cause damage to the product.

Reflow Soldering Profile For Lead-free SMT Process.



NOTES:

1. We recommend the reflow temperature 245°C(+/-5°C). The maximum soldering temperature should be limited to 260°C.
2. Don't cause stress to the epoxy resin while it is exposed to high temperature.
3. Number of reflow process shall be 2 times or less.

Recommended Soldering Pattern (Units : mm; Tolerance: ± 0.1)

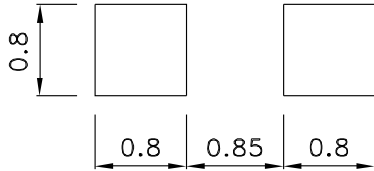

Reel Dimension



Tape Dimensions (Units : mm)

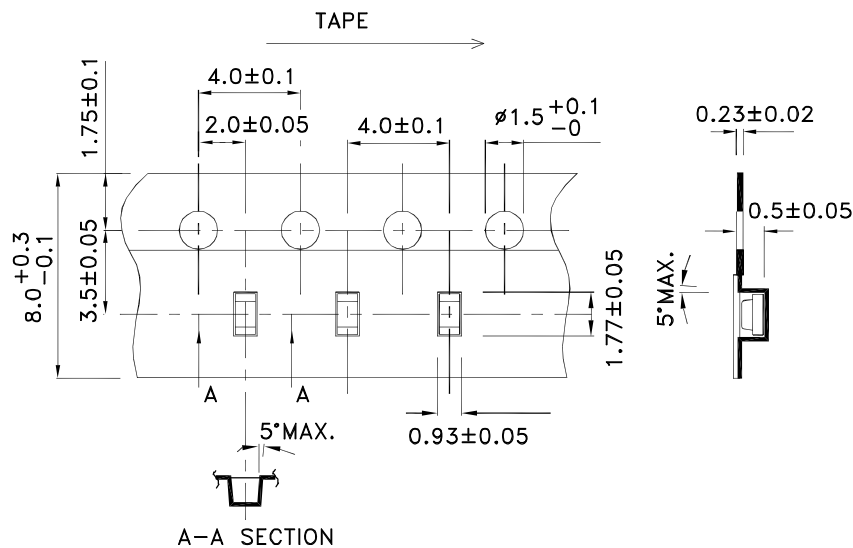

PACKING & LABEL SPECIFICATIONS

APHM1608YCT

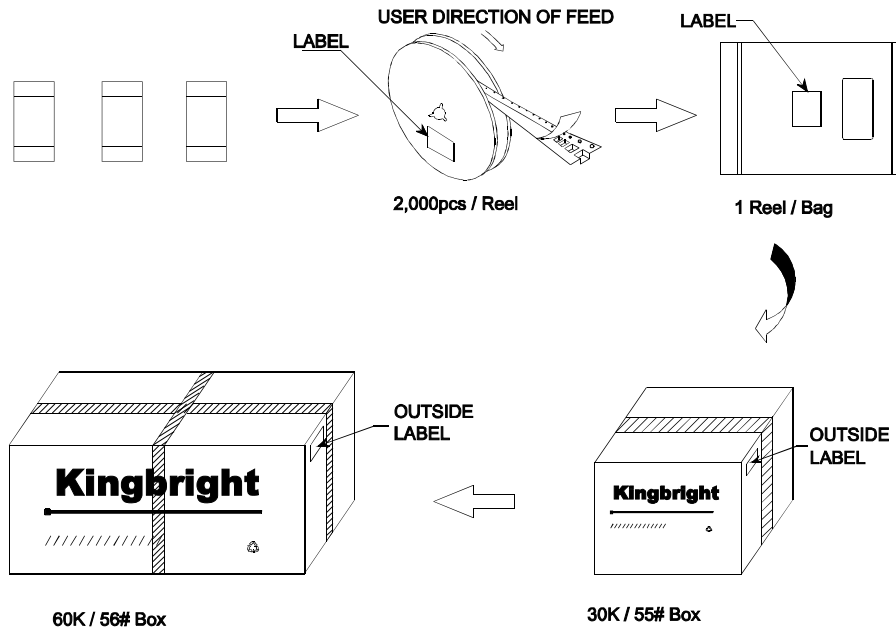

<h1>Kingbright</h1>					
P/NO: APHM1608xxx					
QTY: 2,000 pcs	Q.C.	<table border="1" style="margin: auto;"> <tr><td>Q C</td></tr> <tr><td>XXXXXXX</td></tr> <tr><td>PASSED</td></tr> </table>	Q C	XXXXXXX	PASSED
Q C					
XXXXXXX					
PASSED					
S/N: XXXX					
CODE: XXX					
LOT NO:					
xxxxxxxxxxxxxxxxxxxxxxxxxxxxxxxx					
RoHS Compliant					

Terms and conditions for the usage of this document

1. The information included in this document reflects representative usage scenarios and is intended for technical reference only.
2. The part number, type, and specifications mentioned in this document are subject to future change and improvement without notice. Before production usage customer should refer to the latest datasheet for the updated specifications.
3. When using the products referenced in this document, please make sure the product is being operated within the environmental and electrical limits specified in the datasheet. If customer usage exceeds the specified limits, Kingbright will not be responsible for any subsequent issues.
4. The information in this document applies to typical usage in consumer electronics applications. If customer's application has special reliability requirements or have life-threatening liabilities, such as automotive or medical usage, please consult with Kingbright representative for further assistance.
5. The contents and information of this document may not be reproduced or re-transmitted without permission by Kingbright.
6. All design applications should refer to Kingbright application notes available at <http://www.KingbrightUSA.com/ApplicationNotes>